

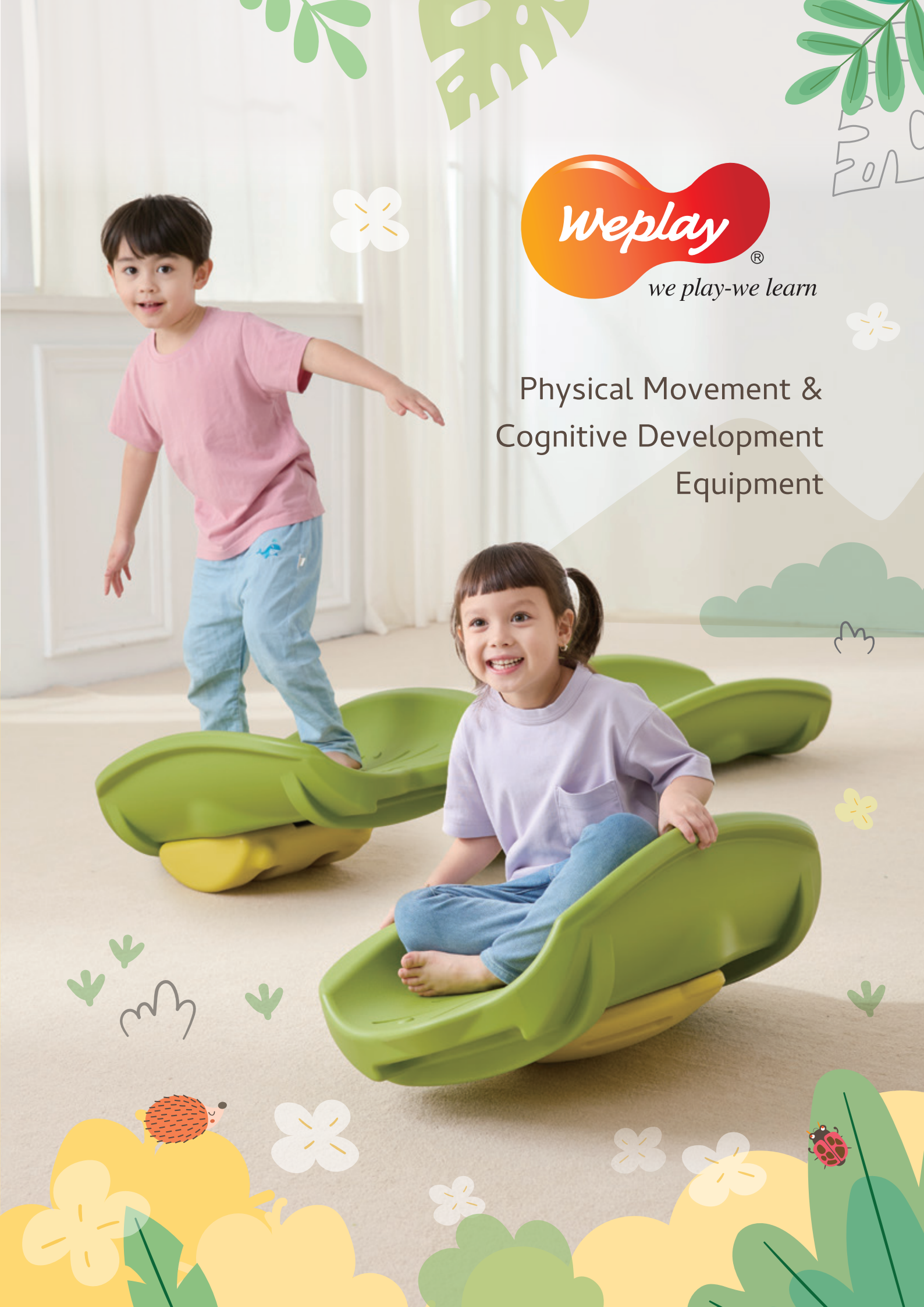

Physical Movement &  
Cognitive Development  
Equipment



# Welcome to Weplay

## Systematic Products for Holistic Development

We here at Weplay develop our systematic products according to children's holistic needs, ranging over visual-auditory-tactile perception, motor skills, balance coordination, fine motor skills, and creative play. Made in Taiwan based on Universal Design, Weplay products help children grow up happily and healthily.

## Bringing Nature Indoors

Our design concept is to bring cultural and natural elements into Weplay products, and therefore children can enjoy outdoor ambiance indoor. A limited place becomes unlimited space when children are having fun with Weplay range.

## Environment, Children's Second Teacher

Either for institutional or household uses, Weplay enriches children's situational activities and creative thinking. With excellent quality, multi-functions and high play value, Weplay belongs to worldwide children. Let's experience Weplay uniqueness together!



## Five Areas of Holistic Development

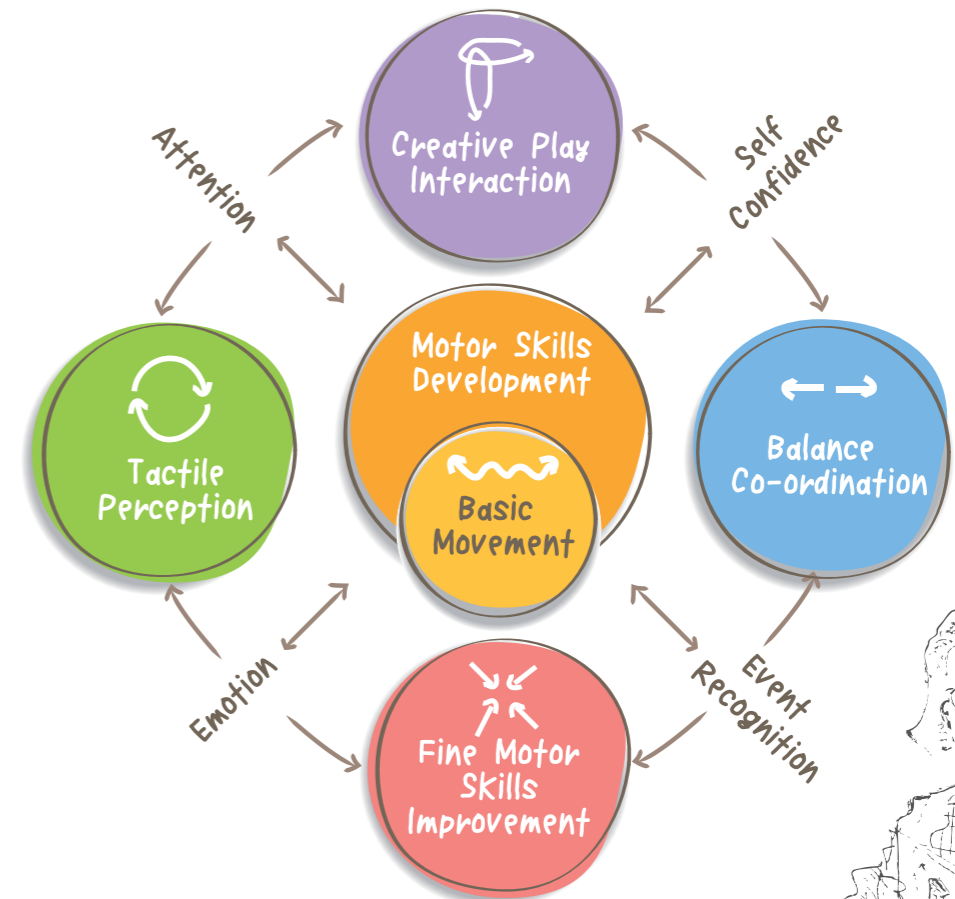

President

*wendy wu*

## Weplay Design by Wendy Wu

### Caring for the children we serve:

- ★ Love as the starting point of design
- ★ Focus on children's developmental needs
- ★ Belief that children are our future
- ★ Mission to help children grow up healthily and happily

### Integrating product design to reflect:

- ★ Everyday life and natural elements
- ★ Eastern wisdom and current international design concepts
- ★ Collaboration from elite team of scholars, educators, medical professional, and designers
- ★ The most natural platform for learning
- ★ Utilization for both institutional and household needs
- ★ Multi-functional & high play value

### Meeting high consumer expectations by:

- ★ Reviewing the past and observing the present to create unforgettable childhood and growing experiences
- ★ Combining theories, experiences, and user testimonies to impact early childhood education
- ★ Promoting teaching methods that relate worldwide and span all cultures

Ms. Wendy Wu, an educator, with over 30 years of theoretical and empirical experience in early childhood education, dedicates herself to continually improving products and curriculum that aide in children's development worldwide.



# Race to the Future

## Weplay

### Innovative products for children's needs

Established in 1987, Kiddie's Paradise Inc. is one of the leading child educational equipment providers in Taiwan. In 1999, we launched the brand "Weplay" with the goal of creating educational products that promote children's communication, motor skills, and stimulate children's creativity while they learn and have fun. Weplay's expertise in early childhood education is the cornerstone of our design objectives to build practical, movable, and storable equipment with high play value that promotes skill development. The distinguished design criteria, based on Universal Design concepts, has led to international recognition and design awards including the Red Dot Design Award of Germany, the iF Design Award of Germany, the Good Design Award (G-Mark) of Japan, and the Taiwan Good Design Product Award.

## Weplay Milestones

### 1987-1988

Kiddie's Paradise Inc. conducted research in childhood education and child development in order to market relevant products.

### 1999

Weplay products firstly appeared on the market.

### 2002

Ms. Wendy Wu received the National Competition of Professional Managers of Research and Development Award.

### 2003

Kiddie's Paradise Inc. received the 10th Small and Medium Enterprise Innovation Research Award.

### 2005

Weplay received the Taiwan Good Brands Award. Mr. Michael Chiu received the National Invention and Creation Award.

### 2006

Three Weplay products were among the "50 Taiwan UD Products" exhibition in Japan.

### 2001-2024

Weplay has received multiple international design awards including iF Design Award of Germany, Red Dot Design Award of Germany, G-Mark Award of Japan, and Good Design Product Award and Excellent product Award of Taiwan. Weplay has also been awarded the Teacher's Choice Awards and AblePlay reviews in the USA.

## Weplay Award Products

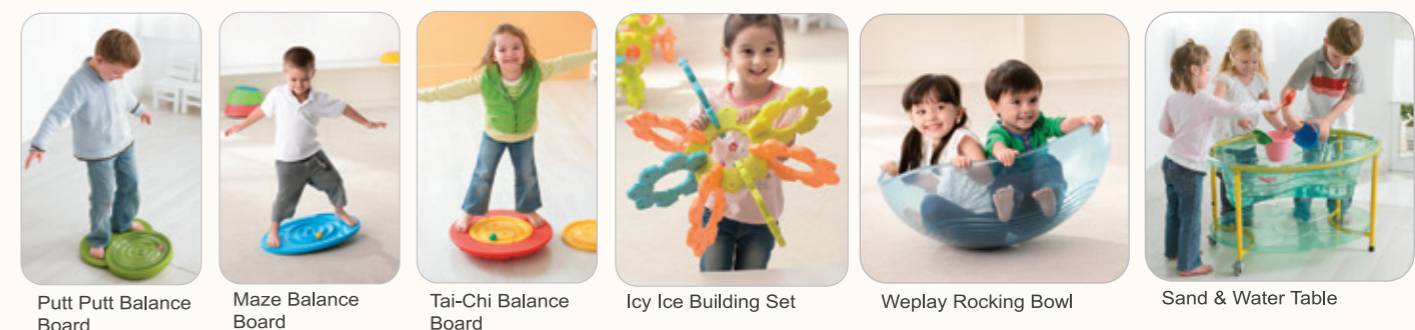
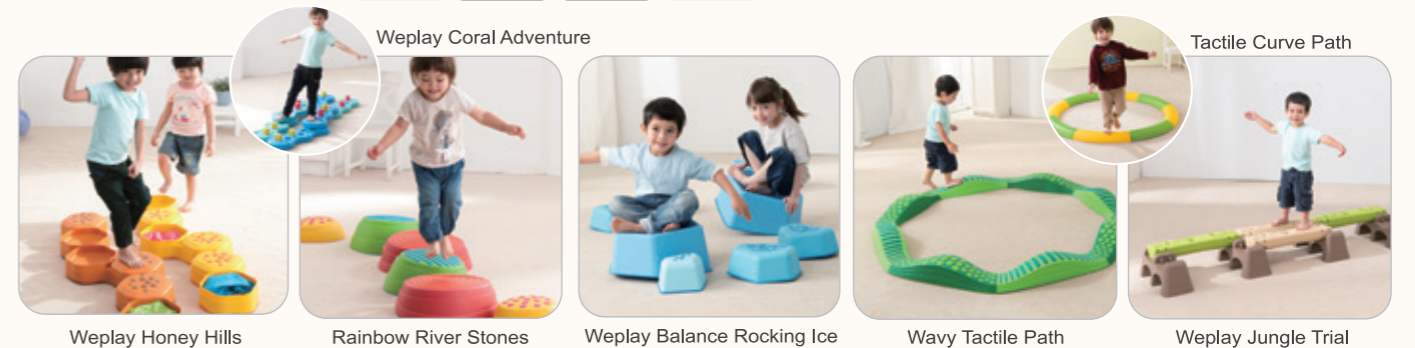



# Weplay Worldwide Distribution

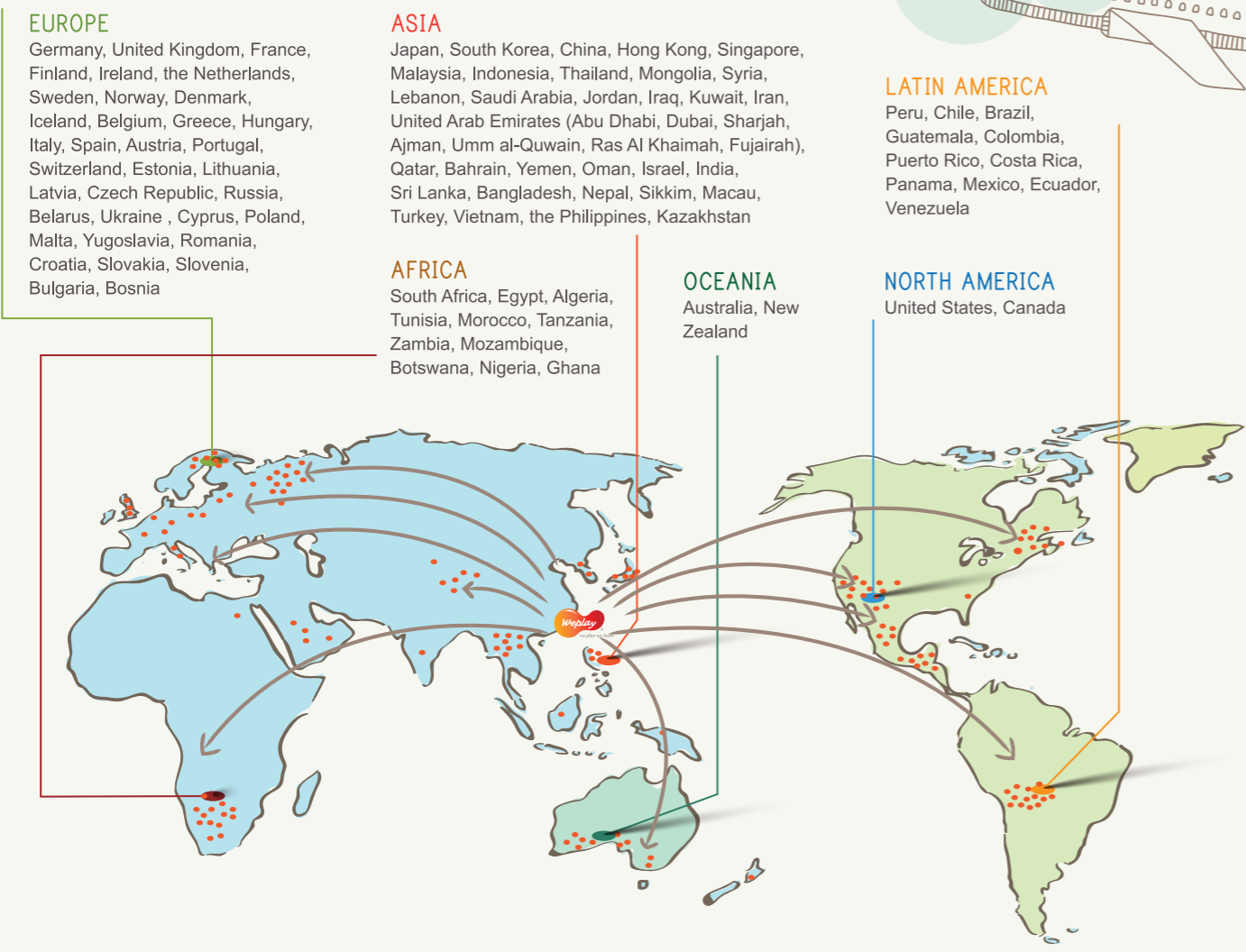

With oriental ingenuity,  
Weplay creates a meaningful  
childhood experience.

- Gentle & Challenging*
- Balanced & Serene*
- Metabolic & Symmetrical*
- Smooth-flowing Rhythm*
- Unhurried & Elegant*



An Exercise of Activating Your Body



## Weplay Awards:



Prepare for International Education Leadership



## Weplay launched **STEAM Jr.** Collection to construct diversified learning basics.

### What is「STEAM」?

**S=Science**   **T=Technology**   **E=Engineering**  
**A=Art**   **M=Mathematics**

STEAM is highly regarded as an educational program utilized in elementary and middle schools internationally. This educational program introduces children to the five disciplines noted above. Rather than teach the five disciplines as separate subjects, STEAM integrates them into a cohesive learning paradigm.

The ultimate goal of education is to apply what you've learned in order to meet practical needs. A STEAM based education shapes children's development through experiences in Science, Technology, Engineering, Arts, and Mathematics. This educational program includes exposure to interdisciplinary learning, hands-on, problem-solving skills, daily skills practice, and the five senses learning.

STEAM education is a fundamental approach towards creative and innovative thinking. The end results are students who are experts in processing information efficiently, make effective use of applicable resources and persist in problem-solving. These skills are essential abilities for a successful future generation.

### STEAM Jr. Helps Young Children, Age 0-6, Prepare for a STEAM Based Education

Weplay products are designed with the core values of We Play, We Learn and We Connect. We offer an educational platform through play and life experiences by engaging in experiential learning.

Weplay products provide the fundamental skills needed for a successful start into these concepts. As our vision connects with the educational concepts of STEAM, we specifically selected a collection of products, we call Weplay STEAM Jr.

To locate these items, look for the  through the catalog.

### Weplay X STEAM Jr. Learning through Play and Nurturing Outstanding Leaders for our Future!

Young children need many activities to acquire the fundamentals and basic knowledge before encountering STEAM.

Weplay has concluded that the following key abilities help prepare children for STEAM:

1. Concentration: Concentration and visual development are interconnected to help children develop their recognition, faculty of memory, searching capability, imagination faculty, and distance prediction ability.
2. Tool Operation: Operating tools to build fine motor skills, gain precision, and hands on experience.
3. Logical Thinking: This includes constructing and deconstructing logic. Understanding the cause and effect of each problem and solve it through innovative thinking.
4. Action Planning: Pre-planning is an important skill that is beneficial for information integration and evaluation ability.
5. Social Interaction: Learn to be a team player by sharing comments openly, willingly, and communicating constructively.

Weplay STEAM Jr. Collection prepares children for an education in STEAM through engaging activities with Weplay products. We are very excited to be a part of this fun learning journey that helps our future leaders establish these important fundamentals in advance!

## The Weplay toys received the world's first **STEAM** accreditation.

When the educational concept, STEAM, becomes popular all over the world, the Toy Association Inc. and The Good Play Guide™ began their cooperation to offer independent third-party reports and the accreditation stamp for worldwide toy companies according to the criteria of TIA STEAM Toy Assessment Framework from 2022. It provides the best accreditation for STEAM toys and the reference for teachers and parents to choose the products they need.



### High-quality Accredited Products

Weplay products are designed with the core value of We play, We learn, connected with the concept of STEAM. Some Weplay products have passed the strict criteria launched by The Toy Association Inc. and The Good Play Guide™. They are mostly rated as 'Excellent' and 'Good' in the reports. Notably, Weplay Sand and Water Clam is included in The Toy Association's "Back to School STEAM Toy Shopping List".

### Tested by Children & Scientifically Proven Evaluation

The evaluation process is strict and practical. The toys are tested by children under professional observation at first. Later, the toys are evaluated with the scientifically proven method by The Good Play Guide™. The evaluation is approved by Dr. Amanda Gummer who has a Ph.D. in neuropsychology and is experienced in working with children and parents for over 20 years. As a result, it is a fair, objective, and trustworthy standard.

### Weplay x STEAM Accreditation

As other Weplay products, these products which received STEAM accreditation are high-quality, interesting and attractive. In addition, the Weplay products provide cross-disciplinary gaming functions for children. As The Toy Association considers that these STEAM accredited products can not only help children actively and independently get involved in learning experiences but also have clear relevance and application to the real world. The Weplay products are equipped with the concept of STEAM Junior and receive the STEAM accreditation. Weplay hopes to help children learn through play and promote their foundational capabilities at an early age.

### Welcome to enjoy the STEAM accredited products!



What's new!



KP2006  
Weplay Rocking Leaf Boat

NEW



P.64



NEW

KM1003  
Weplay Pile Balance Up

P.A9



## KM1003 Weplay Pile Balance Up

NEW

Age: 3y+  
Components:  
Pile x 4 - 38.4 x 33.8 x 23.9 cm (L x W x H)  
Cap x 3 - Ø15.6 x 9.2 cm  
Maximum load: 60 kg

INT'L PAT

3 y+



### Product Feature:

- ★ Pile Balance Up includes narrow stepping spaces and irregular shapes at the bottom. Each Pile has three different heights.
- ★ The Piles can be connected with each other or placed individually to create multiple configurations. It is like an intricate maze in the forest!
- ★ The Cap can not only be placed on the ground to step on but also be stacked on the top of the Pile to create different heights, which enhances children's leg strength when they are stepping up and down.
- ★ The Piles designed to be moved and stored easily are also great for stacking games. The multiple levels of height help develop children's motor skills and balance coordination.
- ★ Different surface designs with anti-slip patterns on the Pile and Cap can provide multiple tactile experiences and ensure children's safety while they are playing.

### Play Value:

- ★ The complicated routes increase children's concentration and help them learn to adapt to different walking environments.
- ★ Stepping up and down the Pile strengthens children's lower body control and joint agility.
- ★ The irregular design of the Pile develops children's foot muscle strength and spatial awareness.
- ★ Various levels of balancing challenges build children's confidence in stepping and walking.

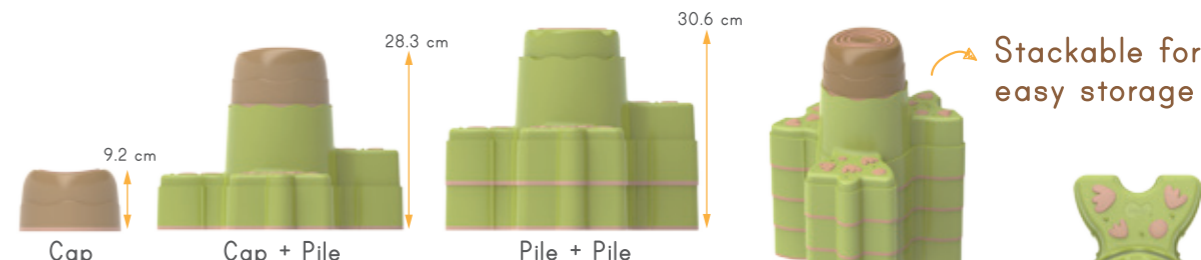

Stackable for easy storage

Each Pile has three different heights.

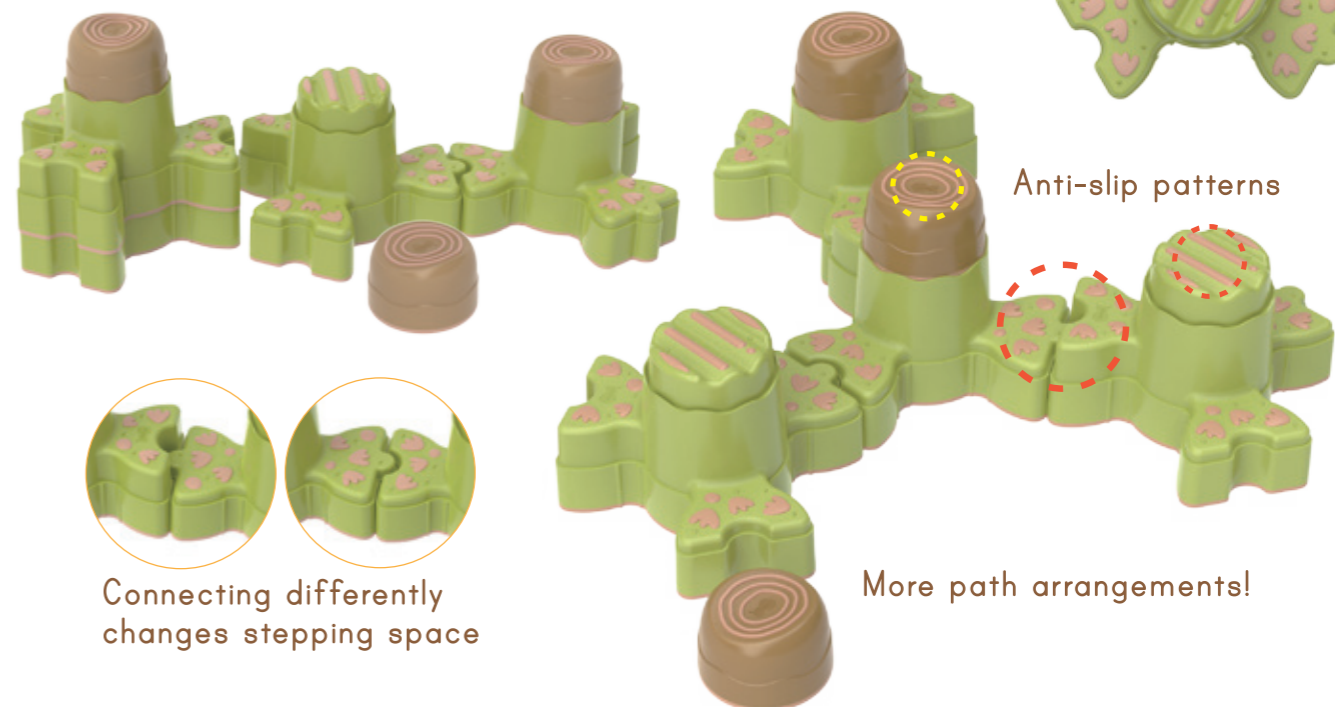

Anti-slip patterns

Connecting differently changes stepping space

More path arrangements!

# Contents

## Motor Skills Development

- 2 Weplay Balance Himalayas KM1002
- 4 Weplay Bridge Rock and Climb KM2017
- 6 Weplay Plan Your Step KM1001
- 8 Weplay Over The Mountain KM2016
- 10 Weplay Forest Tunnel KM3001
- 12 Weplay Coral Adventure KM2015
- 14 Weplay Twiggle Toss KM0005
- 16 Weplay Animal Parade  
KM2808、KM2809、KM2810、KM2811
- 18 Water-Lily KM2012、KM2012-006
- 20 Motor Skill Universal Set KM2000.1
- 21 Motor Skill Basic Set KM2000.1-034
- 23 Weplay Tricky Tree KM0002
- 24 Tai Chi Loop (Ball) KM0001
- 25 Team Walker KM4001.1、KM4001.1-004、  
Follow The Route KM1802
- 26 Weplay Soft Gym  
KM2802-007、KM2802-009、KM2802-012
- 27 Exercise Mat KM2803
- 29 Weplay Trikes (L)(M)(S)  
KM5501、KM5502、KM5503
- 30 Taxi KM5504、Pick-up Trike KM5509、  
Weplay Tuk Tuk KM5516
- 31 Scooter KM5506、KM5507、  
Push Scooter KM5511
- 32 Push Trike KM5505、Walking Bike KM5513
- 33 Edusante Trikes and Bikes

All product dimensions indicated in the catalogue are for reference. There will be certain tolerance subject to actual production.



All product dimensions indicated in the catalogue are for reference. There will be certain tolerance subject to actual production.

## Tactile Perception

- 38 Weplay Sand and Water Clam KT2005
- 40 Weplay Honey Hills KT0016
- 42 Weplay Balance Stepping Clouds KT0012
- 44 Wavy Tactile Path KT0009-00B、KT0009-00G
- 46 Rainbow River Stones KT0008
- 48 Tactile Cube KT1001
- 49 Reflector Cube KT1002
- 50 Construction Tower KT1003
- 51 Gears KT1004
- 54 Sand & Water Table KT2001-00B、KT2001-00C
- 56 Weplay Twister KT3001-003
- 57 Weplay Squeezer KT3002-006
- 58 Sound Block KT5001
- 59 Stepping Stones KT0001.1、KT0001.1-002
- 60 Tactile Straight Path KT0004.1、  
Tactile Curve Path KT0005.1
- 61 Tactile Path KT0003.1、  
Tactile Path+Square KT0002.1-020、  
Square Block KT0004C
- 62 Rungs Way KT0006.1



We care about our future generation. From 2018, Weplay's foam product contains formamide less than 200 ppm which is in accordance with the European standard.

CE ASTM

Not just standard, we care more!

## Balance Co-ordination

- 64 Weplay Rocking Leaf Boat KP2006
- 66 Weplay Rocky Hill KP2005
- 68 Weplay Helix Balance Bridge KP5003
- 70 Weplay Butterfly Path KP4006
- 72 Weplay Rocking Volcano  
KE0011-00B · KE0011-00S
- 74 Weplay Balance Rocking Ice KP4005
- 76 Weplay Nesting Balance Path KP5002
- 78 Weplay Jungle Trial KP5001
- 80 Weplay Wholly Board KP1005-00B · KP1005-00S
- 82 Weplay Rocking Bowl KP2004-00C · KP2004-00G
- 84 Weplay Up On Top KP6106
- 86 Forest Party KP1801 · KP1803
- 88 Weplay Taxi Roller KP6205
- 89 Weplay Pedal Walker KP6204 · Twin Walker KP6202.1
- 90 Go-Go Balance Fun KP4001.1 · KP4001.1-002
- 91 Weplay Balance Arch KP4002 · KP4002-002
- 92 Seesaw KP1001.1 · KP1002.1 ·  
Rocking Seesaw KP1003.1
- 93 Putt Putt Balance Board KP0005
- 94 Circular Balance Board KP0002.1 ·  
Rotator KP2001.1 · Maze Balance Board KP0001.1
- 95 Tai Chi Balance Board (L)(S) KP0003.1 · KP0004.1
- 96 Rotation Board with Handles (S)(L)  
KP2003.1 · KP2002.1-00B

## Fine Motor Skills Improvement

- 98 Weplay Elf's Hanger KF0017
- 100 Weplay Crystal Village KF0016
- 102 Weplay Crystal Carnival KF0015
- 104 Weplay Bean Pods KF0013
- 106 Weplay Apple Links KF0012
- 108 Weplay Cookie Festival KF0010
- 110 Weplay Rock "N" Fish KF0008
- 112 Weplay Jumbo Circus KF0007
- 114 Weplay Rolling 4 Fun KF0009
- 116 Weplay Tricky Fish KF0005 · KF0006
- 117 Infinite Loop (S) KF0002.1
- 118 Forever Up-Down (S) KF0004.1



All product dimensions indicated in the catalogue are for reference. There will be certain tolerance subject to actual production.

## Creative Play Interaction



- 120 Weplay Construction Tiles KC0006
- 122 Weplay Crystal Spectrum Blocks KC2010
- 124 Icy Ice Building Set KC0005
- 126 Weplay Q-Blocks KC0004 · KC0004-032 · KC0004-065
- 128 Weplay Learning Cube KC3001
- 130 Weplay We-Blocks Mini KC3002 · KC3002-028
- 132 Weplay Beanstalk KC2008
- 134 Weplay Puzzle Fun KC2009
- 135 Weplay Stepping Shape KC3004 ·  
Stack n' Stack KC0003
- 136 Weplay Art Block KC2001~ KC2005
- 142 Octagon Creative Blocks KC0001.1
- 143 Brick Me KC0002.1
- 144 Softwood Blocks KC2801 · KC2802 · KC2802-068
- 146 Linkits KC2803
- 147 3D Creative Mat (Color) KC1801-00M
- 148 Nest & Stack KC2805



All product dimensions indicated in the catalogue are for reference. There will be certain tolerance subject to actual production.

## Balls & Fittings

- 150 Weplay Rocking Volcano KE0011-00B · KE0011-00S
- 152 Weplay Chair KE0006 · KE0005 · KE0004
- 153 Cot (L)(M) KE0014 · KE0015 ·  
Modern Ball Chair (S)(L) KE0312 · KE0311-00K
- 154 School Set KB1300 · Baby and Toddler Set KB3301 ·  
Gym Ball KB1303
- 155 Jumping Ball KB1302 · KB1301 · Gym Roll (S) KB1307 ·  
Anti Burst Ball KB1309 · Half Massage UFO KB0304 ·  
Massage Ball KB0306 · To & Fro Ball KB2301
- 156 Air Cushion KT4301 · KT4302 · KT4303
- 157 Olive Massage Ball KT3310 (L) · KT3311 (S) ·  
Massage Roll KT3301 ·  
Massage Ball with Stick KT3304 ·  
Massage Ball KT3308 · KT3307 · KT3306 · KT3305
- 158 Weplay Game-based Teaching Program

To find detail on warnings, please see List of Products.



## List of Product

### Gross Motor Skills

The best energy burners! With crawling, walking, running and jumping, children develop their gross motor and movement skills through the activities.

Product	Product Image	Age	P.
KM2000.1 (M2000) Motor Skill Universal Set		3y+	20
KM2000.1-034 (M1000) Motor Skill Basic Set		3y+	21
KM2012 KM2012-006 S/6 Water-Lily		2y+	18
KM2016 Weplay Over The Mountain		1y+	8
KM2017 Weplay Bridge Rock and Climb		2y+	4
KM2802-007 (M4001) KM2802-009 (M4002) KM2802-012 (M4003) Weplay Soft Gym		2y+	26
KM2803 (M7000) Exercise Mat		0y+	27
KM2808、KM2809 KM2810、KM2811 Weplay Animal Parade		9m+	16
KM3001 Weplay Forest Tunnel		10m+	10
KP1801 (P1101) KP1803 Forest Party		6m+	86

Product	Product Image	Age	P.
KP2005 Weplay Rocky Hill		2y+	66
KP4001.1 KP4001.1-002 Go-Go Balance Fun		3y+	90
KP4002 KP4002-002 Weplay Balance Arch		3y+	91
KP5003 Weplay Helix Balance Path		3y+	68



▲ WARNING: CHOKING HAZARD- Toy contains small parts. Not for children under 3 years.  
 ▲ WARNING: CHOKING HAZARD- Toy contains small balls. Not for children under 3 years.  
 ■ WARNING: STRANGULATION HAZARD- Toy contains strings. Not for children under 3 years.

All product dimensions indicated in the catalogue are for reference.  
 There will be certain tolerance subject to actual production.

## List of Product

### Balance Beams

Walking on the narrow and twisty beams is a great challenge for balance skills. It also lets children practice movement coordination and develop better concentration.

Product	Product Image	Age	P.
KM1002 Weplay Balance Himalayas		3y+	2
KM2015 Weplay Coral Adventure		1y6m+	12
KT0002.1-020 (T0045A) KT0003.1 (T0045) Tactile Path		2y+	61
KT0004.1 (T0004) Tactile Straight Path		2y+	60
KT0005.1 (T0005) Tactile Curve Path		2y+	60
KT0006.1 (T0003) Rungs Way		6m+	62
KT0009-00B (T0009-B) KT0009-00G (T0009-G) Wavy Tactile Path		1y+	44

Product	Product Image	Age	P.
KT0016 Weplay Honey Hills		2y+	40
KP1801 (P1101) KP1803 Forest Party		6m+	86
KP5001 Weplay Jungle Trial		2y+	78
KP5002 Weplay Nesting Balance Path		1y+	76
KP5003 Weplay Helix Balance Path		3y+	68
KC0001.1 (C0001) Octagon Creative Block		6m+	142

All product dimensions indicated in the catalogue are for reference.  
 There will be certain tolerance subject to actual production.

### Stepping Stones

Stepping stones are light and handy. Hopping through the stepping stones practices children's weight shifting skill and reaction time.

Product	Product Image	Age	P.
KM1001 Weplay Plan Your Step		2y+	6
KM1003 Weplay Pile Balance Up		3y+	A9
KT0008 (T0008) Rainbow River Stones		2y+	46
KT0012 Weplay Balance Stepping Clouds		3y+	42
KT0016 Weplay Honey Hills		2y+	40

Product	Product Image	Age	P.
KP1801 (P1101) KP1803 Forest Party		6m+	86
KP4005 Weplay Balance Rocking Ice		2y+	74
KP4006 Weplay Butterfly Path		2y+	70
KC0001.1 (C0001) Octagon Creative Block		6m+	142

## List of Product

### Vestibular & Balance



















Children learn to control their bodies to keep balance on unstable surfaces. It also helps them to develop their vestibular system.

Product	Product Image	Age	P.	Product	Product Image	Age	P.
KP0001.1 (P0001) Maze Balance Board		3y+	94	KP2004-00C KP2004-00G Weplay Rocking Bowl		6m+	82
KP0002.1 (P0002) Circular Balance Board		3y+	94	KP2005 Weplay Rocky Hill		2y+	66
KP0003.1 (P0007) Tai-Chi Balance Board (L)		3y+	95	KP2006 Weplay Rocking Leaf Boat		1y+	64
KP0004.1 (P0008) Tai-Chi Balance Board (S)		3y+	95	KP4006 Weplay Butterfly Path		2y+	70
KP0005 (P0014) Putt Putt Balance Board		3y+	93	KE0011-00S KE0011-00B Weplay Rocking Volcano		3y+	72
KP1001.1 (P0004A) KP1002.1 (P0004B) Seesaw		3y+	92	KT4301 (B0607) KT4302 (B0357) KT4303 (B0307) Air Cushion		0y+	156
KP1003.1 (P0004) Rocking Seesaw		3y+	92	KB0304 (B0018) Half Massage UFO KB0306 (B0751) Massage Ball		0y+	155
KP1005-00B KP1005-00S Weplay Whally Board		1y6m+	80	KB1300 (B1000) School Set		3y+	154
KP1801 (P1101) KP1803 Forest Party		6m+	86	KB1301 (B0554) KB1302 (B0404) Jumping Ball		(S) 3y+ (L) 4y+	155
KP2001.1 (P0006) Rotator		3y+	94	KB1303 (B0852) Gym Ball		0y+	154
KP2002.1-00B (P0009) Rotation Board with Handles (L)		3y+	96	KB1307 (B0003) Gym Roll (S) KB1309 (B0656) Anti-Burst Ball		0y+	155
KP2003.1 (P0010) Rotation Board with Handles (S)		3y+	96	KB3301 Baby and Toddler Set		0y+	154

## List of Product

### Trikes, Bikes & Scooters

Riding trikes, bikes, and scooters is a great way to develop leg muscles and spatial awareness while having fun.

Product	Product Image	Age	P.	Product	Product Image	Age	P.
KM5501 (L) (M5001) Weplay Trike		5-7y	29	EM5501 ES Trike (L)		3-7y	34
KM5502 (M) (M5002) Weplay Trike		4-5y	29	EM5502 ES Trike (M)		3-7y	34
KM5503 (S) (M5003) Weplay Trike		3-4y	29	EM5504 ES Taxi		3-7y	35
KM5504 (M5004) Taxi		3-6y	30	EM5513 ES Walking Bike		3-6y	35
KM5505 (M5005) Push Trike		2.5- 3.5y	32	KP6202.1 (P0005-4) Twin Walker		3y+	89
KM5506 (M5006) Scooter (three wheels)		4-8y	31	KP6204 Weplay Pedal Walker		3y+	89
KM5507 (M5007) Scooter (two wheels)		5-10y	31	KP6205 Weplay Taxi Roller		3y+	88
KM5509 (M5014) Pick-Up Trike		5-9y	30				
KM5511 (M5011) Push Scooter		4-8y	31				
KM5513 (M5013) Walking Bike		3-4y	32				
KM5516 Weplay Tuk Tuk		5-9y	30				

All product dimensions indicated in the catalogue are for reference. There will be certain tolerance subject to actual production.

- ▲ WARNING: CHOKING HAZARD- Toy contains small parts. Not for children under 3 years.
- △ WARNING: CHOKING HAZARD- Toy contains small balls. Not for children under 3 years.
- WARNING: STRANGULATION HAZARD- Toy contains strings. Not for children under 3 years.



## List of Product

### Balls & Equipment

Suitable for every classroom, the balls and equipment are beautiful yet functional.

Product	Product Image	Age	P.	Product	Product Image	Age	P.
KT3001-003 Weplay Twister		3y+	56	KB1307 (B0003) Gym Roll (S)		0y+	155
KT3002-006 Weplay Squeezer		6m+	57	KB1309 (B0656) Anti-Burst Ball		0y+	155
KT3301 (B0007) Massage Roll		0y+	155	KB2301 (B0005) To & Fro Ball		3y+	155
KT3304 (B0077) Massage Ball W/Stick		10m+	155	KB3301 Baby and Toddler Set		0y+	154
KT3305、KT3306 KT3307、KT3308 Massage Ball		0y+	157	KE0004 (C0347) KE0005 (C0307) KE0006 (C0267) Weplay Chair		1y+	152
KT3310 (L) KT3311 (S) Olive massage ball		(L) 0y+ (S) 1y6m+	155	KE0011-00S KE0011-00B Weplay Rocking Volcano		3y+	150
KT4301 (B0607) KT4302 (B0357) KT4303 (B0307) Air Cushion		0y+	156	KE0311-00K (B0509) (L) KE0312 (B0359) (S) Modern Ball Chair		(S) 3y+ (L) Adult	153
KB0304 (B0018) Half Massage UFO		0y+	155	KE0014 (27011) (L) KE0015 (27011) (M) Cot		0y+	153
KB0306 (B0751) Massage Ball		0y+	155	KM2803 (M7000) Exercise Mat		0y+	27
KB1300 (B1000) School Set		3y+	154	KM1802 (M1002) Follow The Route		0y+	25
KB1301 (B0554) KB1302 (B0404) Jumping Ball		(S) 3y+ (L) 4y+	155	KC1801-00M (C1001-C) 3D Creative Mat-Color		0y+	147
KB1303 (B0852) Gym Ball		0y+	154				

All product dimensions indicated in the catalogue are for reference. There will be certain tolerance subject to actual production.

## List of Product

### Social Interaction

It is more fun to play together! Cooperating or healthily competing with each other helps children to develop social skills.

Product	Product Image	Age	P.	Product	Product Image	Age	P.
KM0005 Weplay Twiggle Toss		2y+	14	KP0003.1 (P0007) Tai-Chi Balance Board (L)		3y+	95
KM4001.1 (M8000) KM4001.1-004 (M8000A) Team Walker		3y+	25	KP2002.1-00B (P0009) Rotation Board with Handles (L)		3y+	96
KT0001.1 (T0001) KT0001.1-002 (T0001A) Stepping Stones		3y+	59	KP2005 Weplay Rocky Hill		2y+	66
KT1001 (T1001) Tactile Cube		6m+	48	KP6202.1 (P0005-4) Twin Walker		3y+	89
KT1002 (T1002) Reflector Cube		6m+	49	KP6204 Weplay Pedal Walker		3y+	89
KT1003 (T1003) Construction Tower		2y+	50	KP6205 Weplay Taxi Roller		3y+	88
KT1004 Gears		2y+	51	KF0008 Weplay Rock "N" Fish		3y+	110
KT2001-00B (T0007B) KT2001-00C (T0007C) Sand & Water Table		1y6m+	54				
KT2005 Weplay Sand and Water Clam		1y6m+	38				
KT5001 Sound Block		3y+	58				

▲ WARNING: CHOKING HAZARD- Toy contains small parts. Not for children under 3 years.  
△ WARNING: CHOKING HAZARD- Toy contains small balls. Not for children under 3 years.  
■ WARNING: STRANGULATION HAZARD- Toy contains strings. Not for children under 3 years.

All product dimensions indicated in the catalogue are for reference. There will be certain tolerance subject to actual production.



## List of Product

### Play with Focus

Reaching the goals with focus, children improve their hand-eye coordination, self-confidence and frustration tolerance.

Product	Product Image	Age	P.
KM0001 (M0010-L) Tai Chi Loop (Ball)		3y+	24
KM0005 Weplay Twiggle Toss		2y+	14
KP0001.1 (P0001) Maze Balance Board		3y+	94
KP0003.1 (P0007) Tai-Chi Balance Board (L)		3y+	95
KP0004.1 (P0008) Tai-Chi Balance Board (S)		3y+	95
KP0005 (P0014) Putt Putt Balance Board		3y+	93
KP1001.1 (P0004A) KP1002.1 (P0004B) Seesaw		3y+	92
KP1003.1 (P0004) Rocking Seesaw		3y+	92
KP6106 Weplay Up On Top		2y+	84
KF0002.1 (F0003) Infinite Loop (S)		3y+	117
KF0004.1 (F0004) Forever Up-Down (S)		3y+	118

Product	Product Image	Age	P.
KF0005 (Green) KF0006 (Blue) Weplay Tricky Fish		3y+	116
KF0007 Weplay Jumbo Circus		1y6m+	112
KF0008 Weplay Rock "N" Fish		3y+	110
KF0009 Weplay Rolling 4 Fun		3y+	114
KF0010 Weplay Cookie Festival		1y6m+	108
KF0013 Weplay Bean Pods		1y+	104
KF0016 Welay Crystal Village		2y+	100
KF0017 Weplay Elf's Hanger		2y+	98
KB2301 (B0005) To & Fro Ball		3y+	155



- ▲ WARNING: CHOKING HAZARD- Toy contains small parts. Not for children under 3 years.
- △ WARNING: CHOKING HAZARD- Toy contains small balls. Not for children under 3 years.
- WARNING: STRANGULATION HAZARD- Toy contains strings. Not for children under 3 years.

All product dimensions indicated in the catalogue are for reference. There will be certain tolerance subject to actual production.

## List of Product

### Creative Blocks

Playing blocks provide children the opportunity to unleash their creativity, learn spatial reasoning skills and cultivate artistic sense.

#### A. Large Blocks

Product	Product Image	Age	P.
KT1001 (T1001) Tactile Cube		6m+	48
KT1002 (T1002) Reflector Cube		6m+	49
KT1003 (T1003) Construction Tower		2y+	50
KT1004 Gears		2y+	51
KC0001.1 (C0001) Octagon Creative Blocks		6m+	142
KC0002.1 (C0002-1) Brick Me		2y+	143

#### B. Stacking Fun

Product	Product Image	Age	P.
KF0007 Weplay Jumbo Circus		1y6m+	112
KF0010 Weplay Cookie Festival		1y6m+	108
KF0013 Weplay Bean Pods		1y+	104
KF0016 Welay Crystal Village		2y+	100

Product	Product Image	Age	P.
KC0003 (C4001) Stack n' Stack		4y+	135
KC0004 KC0004-032 KC0004-065 Weplay Q-Blocks		1y6m+	126
KC0005 Icy Ice Building Set		2y+	124
KC0006 Weplay Construction Tiles		3y+	120
KC2801 (C0005) Softwood Blocks		0y+	144
KC2805 (C0010) Nest & Stack		0y+	148





Product	Product Image	Age	P.
KC2805 (C0010) Nest & Stack		0y+	148
KC2801 (C0005) KC2802 (C0015) KC2802-068 Softwood Blocks		0y+	144



All product dimensions indicated in the catalogue are for reference. There will be certain tolerance subject to actual production.

## List of Product

### C. Construction Blocks

Product	Product Image	Age	P.	Product	Product Image	Age	P.
KF0012 Weplay Apple Links		3y+	106	KC2010 Weplay Crystal Spectrum Blocks		3y+	122
KC0003 (C4001) Stack n' Stack		4y+	135	KC2803 Linkits		6m+	146
KC0005 Icy Ice Building Set		2y+	124	KC3001 Weplay Learning Cube		10m+	128
KC0006 Weplay Construction Tiles		3y+	120	KC3002 KC3002-028 Weplay We-Blocks Mini		2y+	130

### Geometric & Spatial Concept

From two-dimensional to three-dimensional, children build up reasoning and problem-solving skills.

#### A. Geometric Shape Matching



Product	Product Image	Age	P.	Product	Product Image	Age	P.
KM0002 Weplay Tricky Tree		1y+	23	KC3001 Weplay Learning Cube		10m+	128
KF0015 Weplay Crystal Carnival		10m+	102	KC3004 Weplay Stepping Shape		10m+	135
KC1801-00M (C1001-C) 3D Creative Mat -Color		0y+	147				

▲ WARNING: CHOKING HAZARD-  
Toy contains small parts. Not for children under 3 years.

■ WARNING: STRANGULATION HAZARD- Toy contains strings.  
Not for children under 3 years.

All product dimensions indicated in the catalogue are for reference.  
There will be certain tolerance subject to actual production.

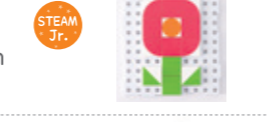
#### B. Spatial Reasoning

Product	Product Image	Age	P.	Product	Product Image	Age	P.
KC2001 (C2001) Pattern Cubes		3y+	137	KC2005 (C2005) Forest		3y+	141
KC2002 (C2002) Rainbow Crystal		3y+	138	KC2008 Weplay Beanstalk		3y+	132
KC2003 (C2003) Fun with Curves		3y+	139	KC2009 Weplay Puzzle Fun		2y+	134
KC2004 (C2004) Ocean		3y+	140	KF0017 Weplay Elf's Hanger		2y+	98



# Motor Skills Development

Children pick up their first motor skills through basic exercise, i.e. crawling, walking, running, and jumping. It is an indispensable process in every child's growth. Children with well developed muscular and skeletal systems will be able to interact more effectively with their peers and the environment.



KM1002

# Weplay Balance Himalayas



Age: 3 y+  
Components:  
Path x 6 (yellow x 3, green x 3) -  
84.2 x 33.5 x 17.9 cm (L x W x H)  
Maximum load: 80 kg

3 y+

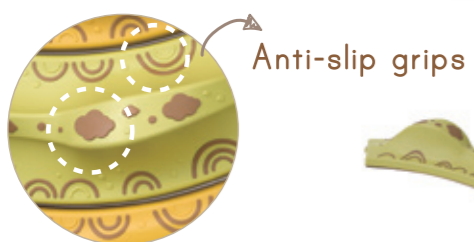
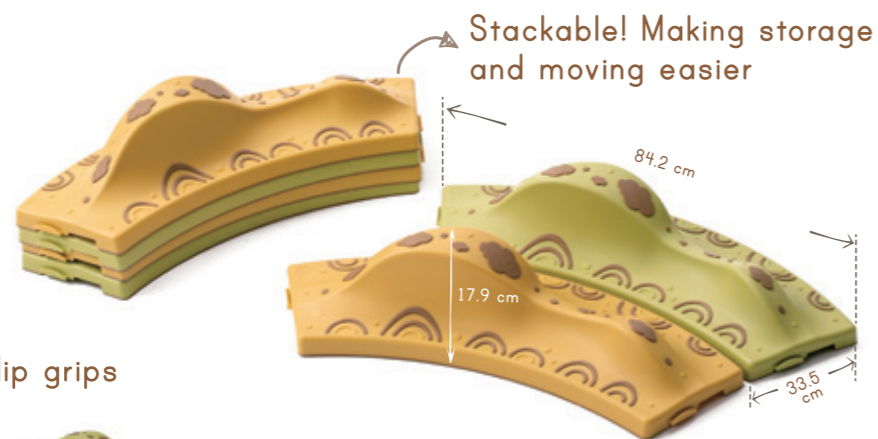

### Product Feature:

- ★ There is a steep and flat hill on the single Path. The up-and-down ridge is narrow and twisting. It creates a challenge for children to balance when walking on it.
- ★ The sides of the ridge provide space for children to place their steps. They can walk on both sides with their legs apart or along the narrow side to the other end.
- ★ Arranging the Paths side by side forms a valley which is suitable for younger children to wander on. Older children can walk on the ridges of different Paths.
- ★ The Paths can be configured as curves, turns and circles. It can also be connected with Wavy Tactile Path, creating a variety of balancing routes.
- ★ The anti-slip patterns are inspired by the clouds over the mountain and a river flowing in the valley. The designs appeal to children and ensure safety.
- ★ The Paths are stackable for easy storage.

### Play Value:

- ★ The narrow ridge creates a challenge for children to keep their balance and control the center of gravity when going up and down.
- ★ Walking on the sides of the ridge helps to enhance the mobility of the lower body and foot strength.
- ★ Either walking on the sides or tops of the two paralleled Paths with legs apart promotes bilateral coordination.
- ★ Assembling the Paths into curves, turns or circles, helps to enhance children's spatial awareness and the ability to adapt to different surroundings.

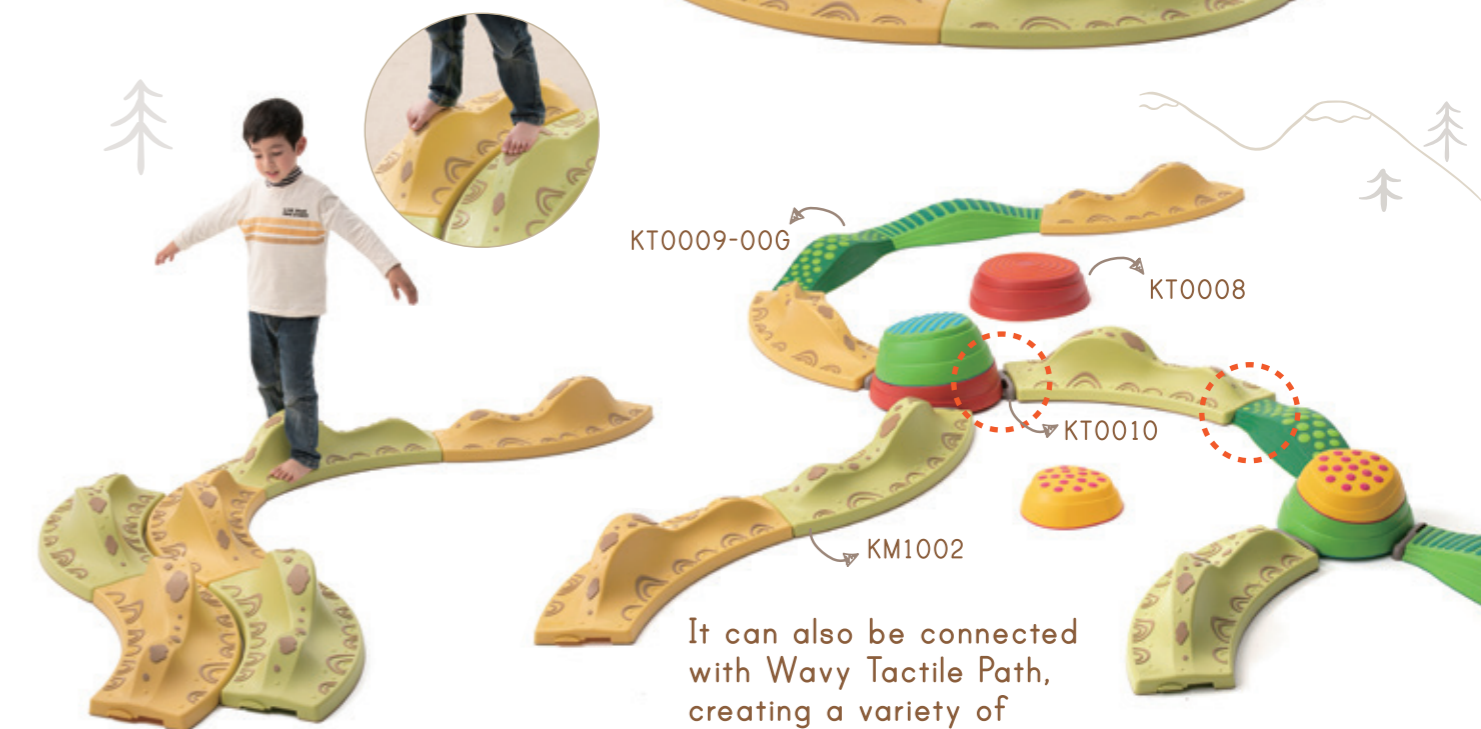
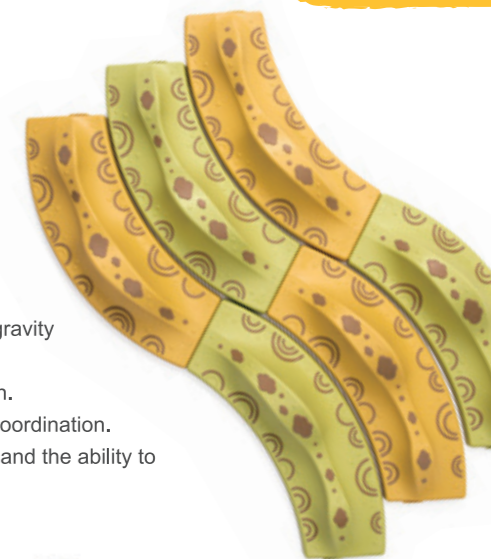

It can also be connected with Wavy Tactile Path, creating a variety of balancing routes.

KM2017

# Weplay Bridge Rock and Climb



Age: 2 y+  
Dimensions: 99.8 × 64.7 × 56.2 cm (L × W × H)  
Maximum load: 60 kg

INT'L PAT

2 y+



The handles also limit the movement while rocking.

**Play Value:**

- ★ The Bridge offers a wide range of physical activities that enhance children's body coordination.
- ★ Climbing the Bridge strengthens the flexibility of children's body movement and physical strength.
- ★ The design sparks children's imagination by rocking it as a magic carpet, which improves their vestibular balance.
- ★ Children can play the Bridge together and learn to use their bodies to exert force when rocking, this activity encourages peer social interaction and teamwork.

**Product Feature:**

- ★ The Bridge provides an array of challenges and fun for children! It serves as a bridge to climb over, a flying carpet to rock on, and a tunnel to crawl through.
- ★ The Bridge is narrower on the top, and wider at the bottom. This design not only reinforces the structural stability but creates challenges for children's adaptation to changes of direction when reaching the top.
- ★ The width of each step fits a child's toes, making climbing more challenging.
- ★ Weplay Bridge Rock and Climb is also designed to be used upside-down as a magic carpet. Children can sit or lie on the bridge while rocking with peers. It creates joyful memories.
- ★ The vividly colored feet are designed with anti-slip texture to ensure safe play.
- ★ The raised handles offer extra support and function as a buffer to limit movement while rocking the Bridge upside-down.

The vividly colored feet with anti-slip texture ensures safety.

2 sets

# KM1001 Weplay Plan Your Step



Age: 2 y+  
Components:  
Sloped Stone x 6 (green x 2, light green x 2, yellow x 2)  
Maximum load: 60 kg

INT'L PAT 2 y+

### Product Feature:

- ★ The unique concave surface design includes both narrow and wide sides to step over, which helps users improve coordination and balance.
- ★ Each set contains 6 pieces. Users can freely rotate the Sloped Stones in different directions to enrich the configurations.
- ★ Weplay Plan Your Step can be arranged into multiple configurations. These formations can create a rocky shore scenario or the rough terrain of a mountain for dramatic play.
- ★ The circular arc-shaped sides allow the Sloped Stones to fit neatly against each other or turn the piece to form gaps. This flexibility provides limitless options.
- ★ The Sloped Stones can be stacked together to create a path of varying height.
- ★ Each Sloped Stone is textured with anti-slip grips, which not only ensures safety but offers different tactile stimulations.
- ★ Weplay Plan Your Step is stackable for easy storage.

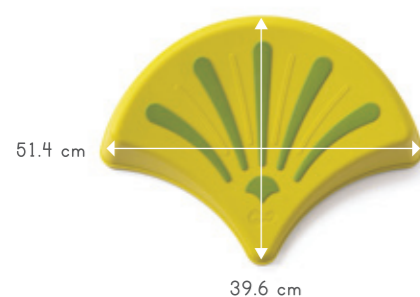

Anti-slip grips

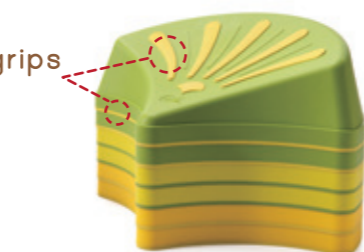

Stackable for easy storage!



### Play Value:

- ★ The Sloped Stone design offers various walking surfaces while boosting balance and coordination skills.
- ★ Alternating the direction of Sloped Stones enables children to have more flexibility in maintaining their center of gravity.
- ★ Assembling multiple Sloped Stones with different heights helps build children's adaptive motor skills.
- ★ Walking along the Sloped Stones strengthens and stabilizes lower body mobility.





# KM2016 Weplay Over The Mountain



Age: 1 y+  
Components:  
Triangle Board x 4  
Wide Board x 2  
Narrow Board x 3  
Nut x 20  
Plastic Wrench x 1  
Maximum load: 60 kg

INT'L PAT 1 y+

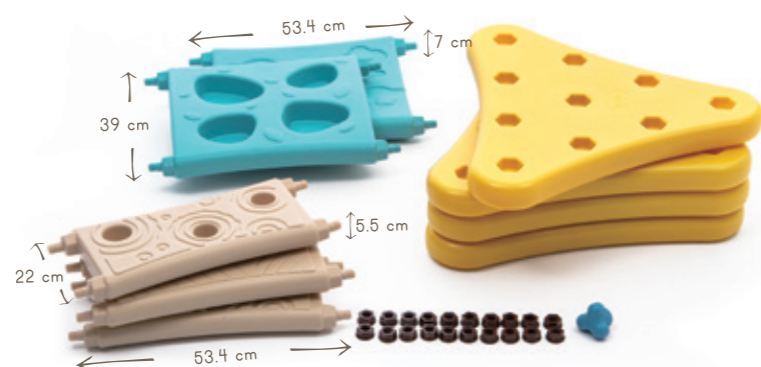

**Product Feature:**

- ★ Weplay Over The Mountain is the first jungle gym experience for young children.
- ★ Wide and Narrow boards are double-sided with different tactile patterns on both sides to offer various combinations.
- ★ The indentations on the Wide and Narrow Board are for climbing and they fit children's hands and feet. These indentations help children to climb easily and safely.
- ★ With multiple holes on the Triangle Board, the Wide and Narrow Boards can be assembled in different positions and are easy to assemble with the provided nuts. Combinations could be changed according to the purpose of the activity, such as a climbing frame, a cave, or a stairway.
- ★ The Triangle Boards can be connected by either the Wide Board or the Narrow Board. The slope of the Wide and Narrow Board can be adjusted to create different challenging levels.

**Different patterns on each side of the board**



Easy to assemble



The first jungle gym experience for young children



**Play Value:**

- ★ Climbing activities can enhance children's motor coordination and physical strength.
- ★ Different patterns on both sides of the boards offer various tactile experiences on children's hands and feet.
- ★ Children's action planning skills can be practiced while stepping over Weplay Over The Mountain. The activity also enhances stability and balance while standing with a single foot.
- ★ Weplay Over The Mountain serves as equipment for physically active games where crawling, climbing, stepping over etc. are involved. The activities improve the flexibility of the children's body movements.



# KM3001 Weplay Forest Tunnel



Age: 10 m+  
 Components:  
 Side Board (brown) × 4  
 Flower / Leaf Pattern Board (green) × 2  
 Nut (orange) × 14  
 Owl Connector (red) × 3  
 Plastic Wrench (blue) × 1  
 Maximum load: 60 kg  
 (When Pattern Board is placed on the ground)



INT'L PAT 10 m+

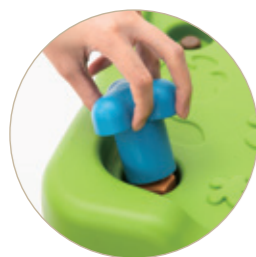

**Product Feature:**

- ★ Open hole design allows light to pass through the Forest Tunnel; this provides visibility for toddlers to crawl through.
- ★ The Forest Tunnels can be placed upside-down; this versatility offers multiple construction options.
- ★ Assorted patterns on each side of the board offer children different sensory inputs and experiences in visual and tactile stimulation.
- ★ The multi-angled design of the Forest Tunnel allows for unlimited configurations.
- ★ Adorable owl-shaped connector reinforces the tunnel structure and provides structural stability.



**Play Value:**

- ★ Crawling boosts the neural connection by stimulating children's tactile, balance system, and hand-eye coordination.
- ★ Crawling or walking with or without hand support on the path helps to develop children's lower body strength.
- ★ Assorted patterns on each side of the Flower/Leaf Pattern Board provide children opportunities to discover and receive tactile sensations.
- ★ Children can create stories and expand their imaginations by crawling into the Forest Tunnel.

The multi-angled design of the Forest Tunnel allows for unlimited configurations.





Age: 1 y 6 m+

Components:

Path x 6 (blue x 3, light blue x 3) - 75 x 23 x 5.5 cm (L x W x H)

Coral Column x 18 (red x 9, green x 9) - 10.3 x 5.5 x 4.5 cm (L x W x H)

Maximum load: 60 kg

INT'L PAT

1y6m+



### Product Feature:

- ★ Weplay Coral Adventure provides multiple activities, such as walking on it as a balance beam to strengthen motor skills and pulling and inserting Coral Column into the Path to enhance fine motor skills.
- ★ Weplay Coral Adventure Path is designed with bubbles, holes, and ripples. The Paths are double-sided and offering different tactile experiences.
- ★ The attachable Coral Columns can be used as connectors for creating different walking routes with various heights.
- ★ The Coral Columns can be placed in any of the holes on the Paths as barriers for more balancing challenges.
- ★ The Coral Columns are strong enough for children to stand and keep their balance on a single foot like a martial artist.
- ★ The superior design offers multiple routes - straight line, curved line, and cross line.
- ★ The adorable fish, shell, bubble, and wave patterns create a perfect ocean scenario for dramatic play.
- ★ The two concavities on the Coral Columns make them easy to pull out.
- ★ The two colors of columns allow teachers to create various rules such as only stepping on the green columns.
- ★ The Coral Columns with raised patterns can also be used as a tool for shaping or stamping in clay activities.

The height of the Coral Column equals the thickness of two Paths.



### Play Value:

- ★ Walking on the Path allows children to practice gross motor skills like balance and coordination.
- ★ Tactile stimulation to the sole is provided by the patterns on the Path and the Coral Columns.
- ★ Different heights and various path combinations promote motor planning abilities and enhance problem-solving skills.
- ★ Children's hand-eye coordination is enhanced by pulling out and inserting the Coral Columns into the Tactile Path.
- ★ Removing the Coral Columns from the Path builds finger and grip strength.
- ★ Stepping over the Coral Columns attached to the path as obstacles trains adaptive skills.
- ★ Weplay Coral Adventure enables children to explore their unlimited imagination and to promote their confidence through role play and teamwork.



# KM0005 Weplay Twiggle Toss



Age: 2 y+  
 Components:  
 Rocking Base x 1 - 25 x 18 x 6.5 cm (L x W x H)  
 Y-shaped Twig x 1 - 32 x 24 x 5 cm (L x W x H)  
 Animal Ring x 6 - Bear Ø 21 x 0.4 cm, Monkey Ø 16 x 0.4 cm  
 Bean Bag x 4  
 (red x 1, yellow x 1, blue x 1, green x 1) - 6 x 6 cm (L x W)  
 Dimensions after assembled: 25 x 18 x 34 cm (L x W x H)

INT'L PAT

2 y+

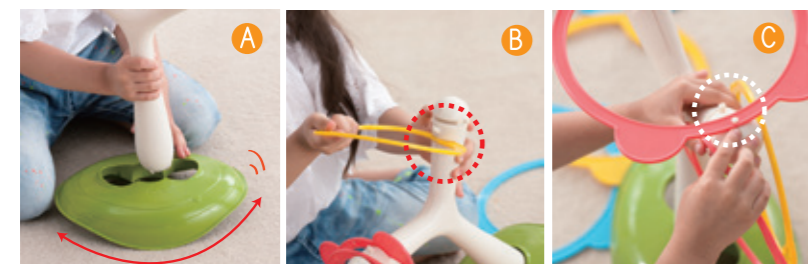

- A** Rocking Base with three holes offers different Twig angles.
- B** Special notch design allows the Animal Rings to attach to the Twig.
- C** Unique protruding points are designed for the Rings to hang on the Twig.



Competition



Combination

Bean Bag toss

**Play Value:**

- ★ Ring toss enhances wrist flexibility and aiming skill.
- ★ Tossing Bean Bags practises hand-eye coordination.
- ★ Encouraging children to assemble Weplay Twiggle Toss by themselves inspires creative thinking.
- ★ Children can increase their frustration tolerance through the game.
- ★ The tossing games are good for visual tracking and attention training.

DIY - Design your own styles!  
 Let's play the tossing game with the Animal Rings and the Bean Bags!

Creative tree designs



Ring toss

able play RATING	
serial #WEPL-TT09-0801-15	
Weplay Twiggle Toss	
DEVELOPMENTAL SKILL	RATING (1-5)
Physical	★★★★★
Cognitive	★★★★★
Social/Emotional	★★★★★
Communicative	★★★★★
Sensory	★★★★

www.ableplay.org

Play products for children of all abilities  
 Independent evaluation by National Lekotek Center

# Weplay Animal Parade



Age: 9 m+  
Maximum load: 60 kg

Low Formamide 9 m+

KM2808 Dinosaur

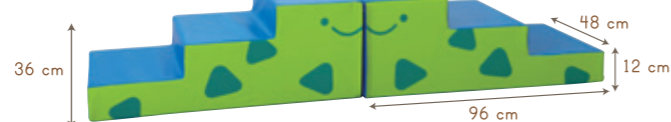

KM2809 Flying Fish

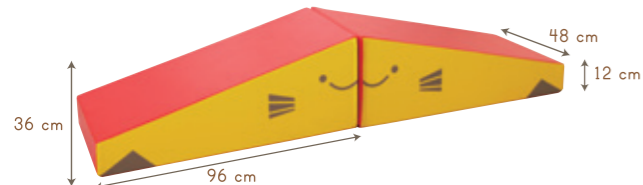

KM2810 Seal

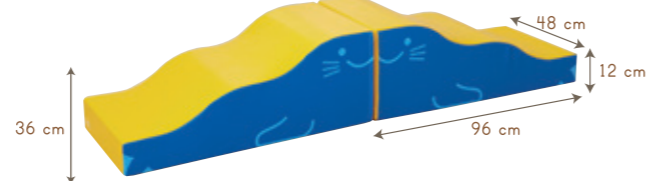

KM2811 Platform

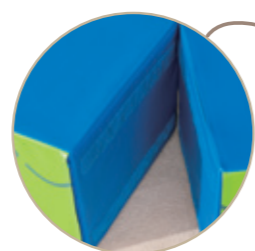
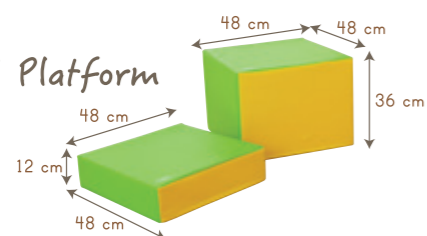

Velcro fastener:  
Animal Parade can be connected with each other easily!

**Product Feature:**

- ★ Weplay Animal Parade is made of high-density foam which is safe and comfortable for young children.
- ★ Wave, ramp and stair designs allow for multi-functional and creative arrangements.
- ★ The cover can be easily cleaned with a damp cloth.



**Play Value:**

- ★ Weplay Animal Parade helps to develop young children's motor skills such as crawling, walking, and going upstairs and downstairs.
- ★ Children's physical coordination, flexibility and balance skills can be promoted through the activities with Weplay Animal Parade.
- ★ Cute animal figures enrich children's imagination and creativity.



# Water-Lily



Age: 2 y+  
Maximum load: 40 kg

**KM2012**  
Island x 8  
Flat Bridge x 2  
Curvy Bridge x 2

**KM2012-006**  
Island x 4  
Flat Bridge x 1  
Curvy Bridge x 1

INT'L PAT



2 y+



(Different Patterns on Each Side)

**Product Feature:**

- ★ Inspired by a pool of water lilies, this product consists of green stackable Islands and blue connecting Bridges.
- ★ There are different textures on the Bridges and Islands, such as petals, bubbles, waves, ripples, and sparkles.
- ★ Anti-slip material is used for safety.



**Play Value:**

- ★ Children can freely create amazing paths in situational activities with these beautiful components.
- ★ Water-Lily enhances physical coordination, agility, and balance skills.
- ★ Playing with Water-Lily cultivates children's spatial concepts, action planning skills and problem-solving skills.



Anti-slip material

To maintain the excellent quality of this product, do not leave it outdoors for an extended period of time.



The set includes bricks, poles, hoops, clips, balance beams, and other equipment targeting coordination. The motor skill education series is ideal for various age groups and meets the demands for development and theme based exercises.

## KM2000.1 Motor Skill Universal Set

Age: 3 y+

Components:

Half Brick	12 pcs	Brick	8 pcs
Hoop 35 cm	4 pcs	Hoop 60 cm	4 pcs
Pole 35 cm	16 pcs	Pole 70 cm	8 pcs
Clip A	12 pcs	Clip B	12 pcs
Bean Bag	10 pcs	Balance Beam	4 pcs
Handprint	6 pairs	Footprint	6 pairs

Carrying Bag dimensions: 71 x 83 x 15 cm (L x W x H)

Balance Beam maximum load: 50 kg



## KM2000.1-034 Motor Skill Basic Set

Age: 3 y+

Components:

Half Brick	8 pcs
Pole 35 cm	2 pcs
Pole 70 cm	2 pcs
Brick	8 pcs
Balance Beam	4 pcs
Hoop 60 cm	2 pcs
Clip A	4 pcs
Clip B	4 pcs

Carrying Bag dimensions:

60 x 81 x 15 cm (L x W x H)

Balance Beam maximum load: 50 kg



able play RATING	
Weplay Motor Skill Universal Set	
serial #WEPL-MS10-0801-15	
DEVELOPMENTAL SKILL	RATING (1-5)
Physical	★★★★★
Cognitive	★★★★★
Social/Emotional	★★★★★
Sensory	★★★★★
Communicative	★★★★★
www.ableplay.org	
Play products for children of all abilities Independent evaluation by National Lekotek Center	

# Replacement Sets

Brick & Hoop



Pole & Pole with Clip B

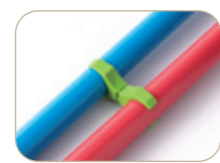

Hoop & Pole with Clip A



Brick & Pole

Half Brick & Brick KM2001.1  
Half Brick x 8 - 13.5 x 13.5 x 8.5 cm (L x W x H)  
Brick x 8 - 27 x 13.5 x 8.5 cm (L x W x H)



Pole KM2004.1  
S x 4 - 35 cm  
L x 4 - 70 cm



Balance Beam KM2002.1  
Balance Beam x 4  
81 x 13.5 x 4 cm (L x W x H)



Clip A KM2005.1  
Clip A x 12  
(for Hoop & Pole)  
6.6 x 4 x 3.7 cm (L x W x H)



Clip B KM2006.1  
Clip B x 12  
(for Pole & Pole)  
7.3 x 3.6 x 1.4 cm (L x W x H)

## Footprint & Handprint KM2008.1

Handprint x 6 pairs - 20 x 15.5 x 0.5 cm (L x W x H)  
Footprint x 6 pairs - 23 x 10 x 0.5 cm (L x W x H)  
The textured surfaces provide hands and feet tactile stimulation. These are made of an anti-slippery material to prevent sliding.

The size and the density of the protruding dots are designed with the consideration of nerve locations in feet and hands.



Anti-slip material

## Bean Bag KM2007.1

Bean Bag x 10 pcs - 12.5 x 12 x 2 cm (L x W x H)  
Brightly colored Bean Bags are designed with dual layers to prevent contents from spilling. They can be used in various games and activities such as tossing, grabbing, sorting or even for massage.



## Hoop KM2003.1

Components: Ø 35 cm x 4, Ø 60 cm x 4  
The durable hoops can be played with in many ways.



Flexible and durable

Flat design for safety



# KM0002 Weplay Tricky Tree



Age: 1 y+  
Components:  
Green Bough x 1  
Base Board x 1  
Disc x 6 (yellow x 3, orange x 3)  
Dimensions after assembled: 31 x 31 x 41 cm (L x W x H)

INT'L PAT 1 y+



**Description:**  
Children need to follow the twig direction to turn the discs onto the Bough. Weplay Tricky Tree is not only for wrists but also for whole-body movement. The product is designed to help develop children's problem-solving abilities.

**Product Feature:**  
★ Adorable cactus and discs with lively facial expressions draw children's attention.  
★ Discs with 7 different raised shapes on one side and 3 facial expressions on the other.  
★ Putting or taking the discs into or out of the bough is an interesting 3D puzzle game.

**Play Value:**  
★ Weplay Tricky Tree enhances the coordination of body movements.  
★ The discs help children to learn different shapes.  
★ Putting the Discs onto the Bough allows children to the spatial and directional concepts.  
★ Children's observation and logical thinking skills are trained when playing Weplay Tricky Tree.  
★ 3 different facial expression discs help children to learn more about emotion and role-playing games.



3 facial expressions



able play RATING	
Weplay Tricky Tree	
serial #WEBL-TT03-0701-12	
DEVELOPMENTAL SKILL	RATING (1-5)
Communicative	★★★★★
Cognitive	★★★★★
Social/Emotional	★★★★★
Physical	★★★★★
Sensory	★★★★★

www.ableplay.org  
Play products for children of all abilities  
Independent evaluation by National Lekotek Center



Putting or taking the Discs into or out of the Bough is an interesting 3D puzzle game.



# KM0001 Tai Chi Loop (Ball)

Age: 3 y+ Dimensions: Ø 20 cm



**Description:**

Tai Chi Loop (Ball) is inspired by the philosophy of Oriental Tai Chi, which explores physical potentials through the essences of harmony, symmetry, and circulation. When playing with this product, we move our wrists, arms, and bodies rhythmically - just like doing Tai Chi exercise.

**Product Feature:**

- ★ Tai Chi Loop (Ball) is designed for users to imitate the movements of Tai Chi exercise.
- ★ The innovative "ball-in-ball" design keeps the small ball contained while allowing for movement.
- ★ The inner track has a textured pattern to indicate the side for the small ball to roll along.
- ★ The innovative "ball-in-ball" design is visually exciting and eye-catching.

**Play Value:**

- ★ Tai Chi Loop (Ball) is an excellent product for eye-tracking and hand-eye coordination exercises.
- ★ The activities build children's frustration levels in a contained environment.
- ★ Tai Chi Loop (Ball) strengthens flexibility, coordination, and concentration.

## Tai Chi Loop (Ball)

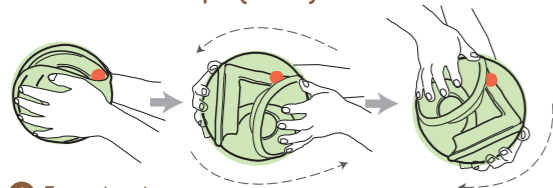

1 Entry level:  
Keep the inner ball rolling along the track with wrist movements.

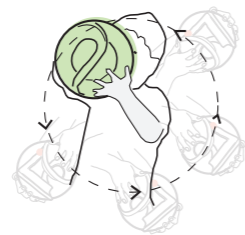

2 Intermediate level:  
Keep the inner ball rolling along the track with arm movements.

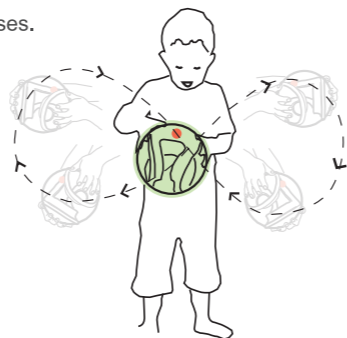

3 Advanced level:  
Keep the inner ball rolling along the track with body movements.



# KM4001.1 (4 pairs / set), KM4001.1-004 (2 pairs / set) Team Walker

Age: 3 y+  
Dimensions: 39.5 x 12.5 x 2.5 cm (L x W x H)

**Components:**

KM4001.1 (4 pairs / set)	KM4001.1-004 (2 pairs / set)
Board × 8	Board × 4
String × 8	String × 4
Rubber Strap × 8	Rubber Strap × 4
Handle × 8	Handle × 4
Plastic Clip × 16	Plastic Clip × 8



1、2、1、2.....Left and right.  
Everybody all together!



The adjustable rubber strap fits all foot sizes. Each board can be firmly connected and locked to each other!



- ★ The unique design emphasizes individuals' motor skill development and team coordination.
- ★ Team Walker is a highly portable activity set. It is not space-constrained and provides multiple ways to play.
- ★ Two to four users can play Team Walker together. It promotes teamwork and social interaction.
- ★ The activities are suitable for schools and nurseries, indoors and outdoors.

# KM1802 Follow The Route

Age: 0 y+  
Dimensions: 50 x 50 x 1.5 cm (L x W x H)

**Product Feature:**

- ★ Each piece has two sides. One side has blue symbols with a yellow background and another side is the opposite.
- ★ It is made of durable high-density foam without glue.

**Play Value:**

- ★ Activities with Follow The Route could establish children's spatial and directional concepts.
- ★ Walking on the designated routes improves action planning ability, balance and stability.
- ★ It can be used to promote interest in learning and promote concentration.

**Components:**



Total: 12 pcs



Different colors on both sides



It can be used with Stepping Stone (KT0001.1) to make the activity more challenging!

# Weplay Soft Gym



Weplay Soft Gym is a basic motor skills training set for a flexible play experience. This set helps to improve young children's balance and coordination. From basic body stretches to spatial awareness concepts, Soft Gym has everything needed to enhance and challenge children's physical development.

Age: 2 y+  
Maximum load: 40 kg

2 y+

**KM2802-007** 7 pcs / set  
Basic motor skills training and game playing

**KM2802-009** 9 pcs / set  
Experience different games in varied spaces

**KM2802-012** 12 pcs / set  
A complete and comprehensive motor skill training set



KM2802-009

Low  
Formamide

Shape	KM2802A	KM2802B	KM2802C	KM2802D	KM2802E	KM2802F	KM2802G	KM2802H	KM2803A-00R	Total
KM2802-007	2	1					2		2	7 PCS
KM2802-009	2		1	1	1		2		2	9 PCS
KM2802-012	2	1	1			2	2	2	2	12 PCS

Please use the product on a padded mat to ensure safety.



KM2802-007 + KM2802-009

Soft Gym set helps to improve balance and coordination.



KM2802-012

KM2802-012

High-density and durable material

## KM2803 Exercise Mat

Age: 0 y+  
Dimensions: 120 x 60 x 5 cm (L x W x H)

0 y+

Low  
Formamide

### Product Feature:

- ★ The Mats are made of durable high-density foam.
- ★ Velcro sides allow the Mats to connect with each other in limitless ways.
- ★ Exercise Mat can be used either individually or connected to make a larger-sized mat.
- ★ The thick and firm Mat provides better safety during games and activities.

### Play Value:

- ★ Exercise Mat can be used for different body movements and stretches.
- ★ With Exercise Mat as protection for activities, children can play with more confidence.



Velcro fastener for a firm connection

Supplied in assorted colors



The surface can be cleaned by wiping with a damp cloth.

## Design Philosophy

The curvilinear form of design was inspired by the flow of natural elements (wind and clouds etc.) and ancient Chinese calligraphy. These patterns can be seen repeatedly in traditional Chinese relics and historical artifacts. Instead of using hard and stiff lines, Weplay trikes employ soft and curvy lines inspired by the ancient "feitian" (Asparas) images found in the cave apex in Dunhuang, China.

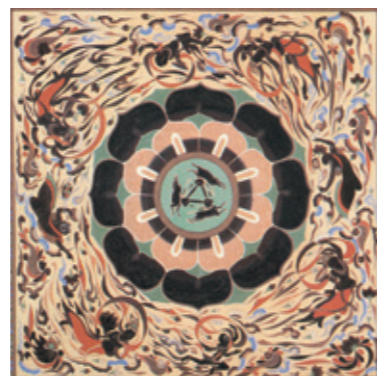

"Three hares and feitian" – Image on the ceiling apex in cave 407, Dunhuang, China, dated to the Sui Dynasty (589-618).

## Product Feature

The unique streamlined body and the comfortable seat of the trikes provide the best fit for the children. Children improve their balance, coordination and motor skills through riding the Weplay trikes. Red and yellow are traditional Chinese colors that represent fortune, happiness, and luck.



KM5501

KM5502

KM5503



KM5504

KM5505

KM5506

KM5507



KM5509

KM5511

KM5513

KM5516

## Weplay Trikes INT'L PAT

KM5501 (L), KM5502 (M),  
KM5503 (S)



### Basic Series

Three sizes for children of different ages

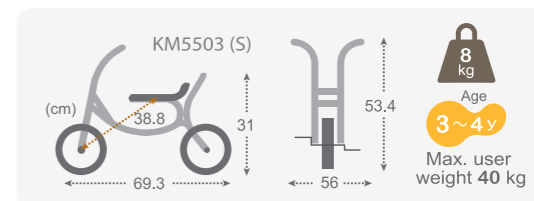
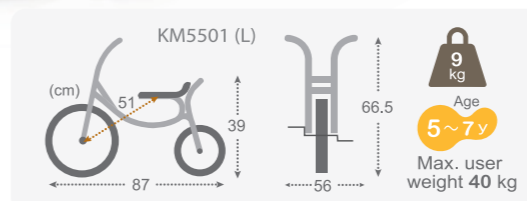
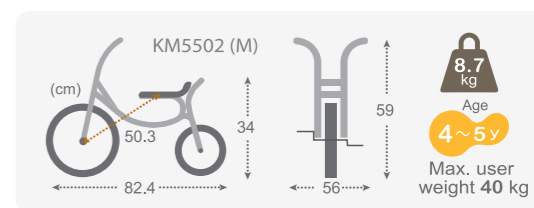

## Weplay Trike Features

The trikes are designed with heavy-duty frames, ensuring durability even for frequent use in institutions.

## Cooperative Riding Series

These trikes are designed to encourage teamwork, cooperative play, and role play with peers.



Taxi KM5504

Cooperative riding helps children to learn to communicate with each other.



KM5504

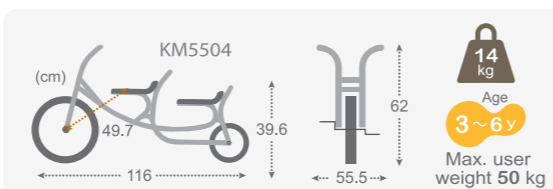

KM5509

Handrail for passenger's safety

Pick-Up Trike KM5509

The cooperative trike is designed especially for children above five years of age.



KM5509

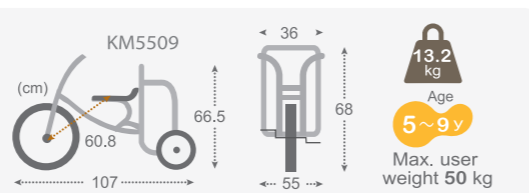

KM5516

Weplay Tuk Tuk KM5516

It is suitable for three children.

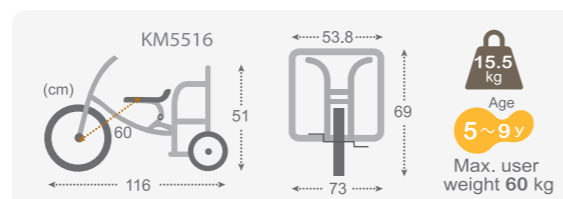

KM5516

## Scooter Series

This series is fun and challenging! Without a seat or pedals, children are free to explore and discover the environment while scooting around!

Scooter (three wheels) KM5506

Scooter (two wheels) KM5507

The scooter is propelled by one foot. Children learn to utilize and develop their sense of balance while working on physical coordination through scooting.



KM5506



KM5507



KM5506



KM5507

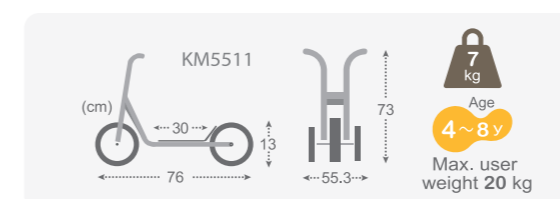
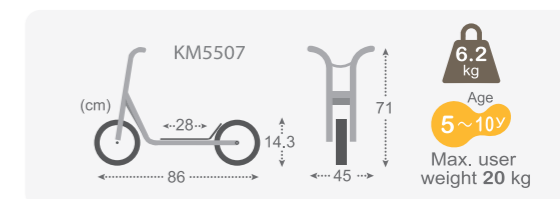
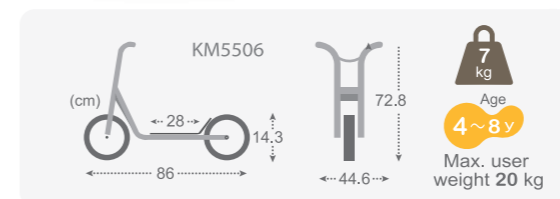

Push Scooter KM5511

The design of the Push Scooter gives children a better balancing three-wheeled platform while developing coordination and balance skills. The design is also easier for children to get on and off the scooter.



KM5511



KM5511

## Push Trike (three wheels, no pedal) KM5505

A pedal-less tricycle that helps children with motion practice, balance training, and leg muscle development.

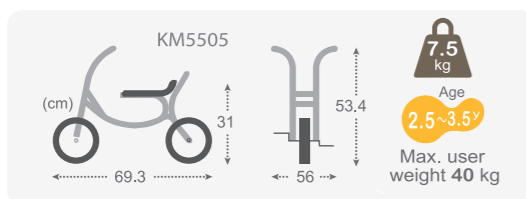

## Walking Bike (two wheels, no pedal) KM5513

A pedal-less bicycle that helps children with motion practice, balance training, and leg muscle development.

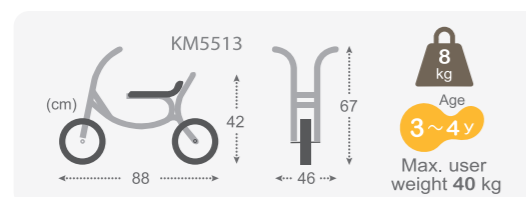

# Edusante Trikes

With Weplay's high level of expertise in early childhood education, Weplay's design objectives are collaborated with innovative production techniques to create Edusante trikes.



This trike set offers extraordinary sturdiness. This is a necessity for early childhood institutions.

### ES Trike (L) EM5501

Age: 3-7 y

Riding on this standard large trike promotes children's physical fitness.

INT'L PAT

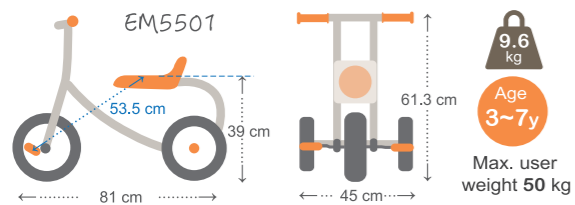

### ES Trike (M) EM5502

Age: 3-7 y

It provides children with a great first riding experience! This trike helps to build leg muscle endurance.

INT'L PAT

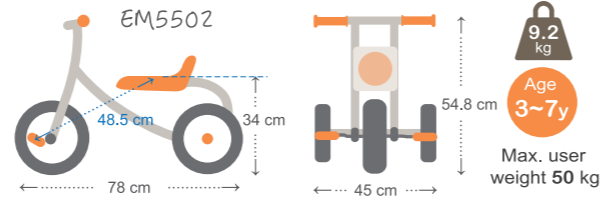

### ES Taxi EM5504

Age: 3-7 y

ES Taxi doubles the fun with 2 seats! It not only encourages peer social interaction but also develops the concepts of sharing, waiting, and taking turns.

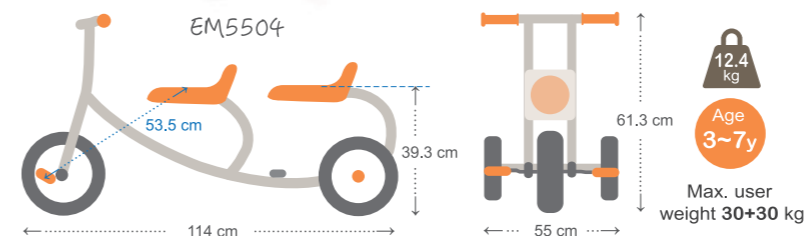

### ES Walking Bike EM5513

Age: 3-6 y

Pushing the Walking Bike with feet helps children to learn balance maintenance while they are riding the bike. It is a perfect bike that brings fun for children of different ages.

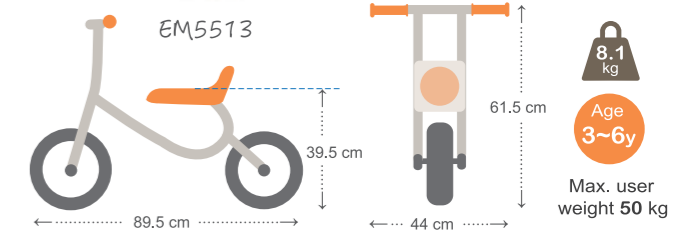

Tolerances of the measurements are ±1 cm.

### Riding on the Edusante trikes benefits children's hearts, minds, and bodies!

- ★ Children's gross motor skills and balance coordination are promoted.
- ★ Riding the trikes helps to strengthen children's action planning skills.
- ★ Children build special concepts comprehensively while riding the trikes.
- ★ The trikes encourage peer social interaction.

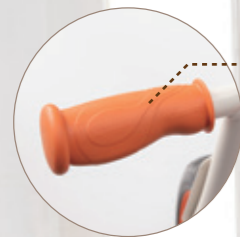

The soft handlebar grips with side impact protection provide additional safety.



The wide seat design ensures a comfortable riding position.



The trikes are designed with a turning limit for safety purposes.



The Edusante magnetic signs (sold separately) are attachable to the front plate of the trikes.



The sturdy frame construction is designed for long-lasting use.



The evolved, soft, and quiet tires provide extra comfort.

The floral-shaped rim with no gaps prevents entrapment.



The solid pedals prevent finger entrapment.



It is great for roleplay! Two sets of magnetic signs available.

#### Edusante Magnetic Number Set EM5530

Age: 2 y+  
Components: Magnetic Sign x 6 (number 1 to 6)  
Dimensions: 15 x 15 cm (L x W)



#### Edusante Magnetic Role Play Set EM5531

Age: 2 y+  
Components: Magnetic Sign x 6 (6 professions)  
Dimensions: 15 x 15 cm (L x W)



#### Product Feature:

The Edusante Magnetic Sets are designed for the ES series. The magnetic signs are easy to attach and change to the front plate of the trikes and bikes. They can also be attached on other metal surfaces such as refrigerators and whiteboards.



## Tactile Perception

The sense of touch is the fundamental element of sensory reactions. It is an essential ingredient for enhancing learning ability and emotional intelligence.



# Weplay Sand and Water Clam



Age: 1 y 6 m+

Components:

Sand and Water Clam (Tub, Lid, Adjustable Stand) x 1

Accessory Set

(Funnel x 1, Water Slide x 2, Water Wheel x 2, Scoop x 1) x 1

Dimensions: 66.6 x 82 x 45~59 (L x W x H)

Maximum load: 60 kg

Maximum volume: 40 L

INT'L PAT

1y6m+



### Product Feature:

- ★ This ocean-themed sand and water play set provides new levels of exploration and engaging play.
- ★ The transparent tub with a stepped edge design allows children to experience variations in depth. Two round compartments are designed for storing accessories and make opening and closing the lid easy.
- ★ When the lid is set upright in the tub the accessories can be mounted on both sides with the accompanying suction cups. Children can easily arrange the funnel, water wheels, and water slides for variations in water flow.
- ★ Children can use the lid as a tray for sand drawing or to build sandcastles. It also acts as a storage tray when placed below the tub.
- ★ Weplay Sand and Water Clam can be used with or without the stand which can be adjusted into three different heights. With the two locking casters, Sand and Water Clam can be moved from room to room or indoors to outdoors. The locking feature secures the table in place.
- ★ The drain plug makes draining and cleaning the sand and water table easy.

Pour water from both sides of the Scoop



### Play Value:

- ★ Children can learn the natural properties of sand and water while being introduced to the concept of depth.
- ★ By arranging the accessories to make water flow in different directions, children develop their problem-solving skills.
- ★ Sand and water play provide children different sensory experiences which is beneficial for emotional growth.
- ★ Up to 6 children can play around Weplay Sand and Water Clam together. Children learn to share and communicate with their peers.

### Storage compartments for accessories



## KT2005B Accessory Set

1y6m+

STEAM Jr.

Age: 1 y 6 m+

Components: Funnel x 1, Water Slide x 2, Water Wheel x 2, Scoop x 1

- ★ Designed with a suction cup, the accessories can be mounted on both sides of the Lid or other smooth surfaces.
- ★ Mounting the accessories freely on the Lid to create variations in water flow, which helps to develop problem-solving skills.





# KT0016 Weplay Honey Hills



Age: 2 y+  
 Components:  
 Honey Hill x 6 (yellow x 3, orange x 3)  
 Hexagonal Tactile Bag x 3 (red x 1, blue x 1, green x 1)  
 \*Tactile materials not included  
 Maximum load: 80 kg

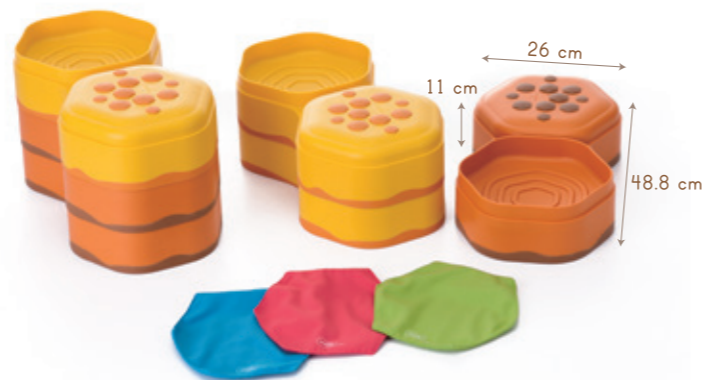

**Description:**  
 Inspired by the natural shape of the honeycomb, Honey Hills adopts the concept of tactile containers and turns them into a stimulating stepping game. Children can create paths with various heights and routes to explore the different textures with their feet, which enhances motor skills and stabilizes emotions.



Combination of two sets or more for more challenges and fun



2 sets



3 sets

able play RATING	
Weplay Honey Hills serial #WEPL-HH08-0801-15	
DEVELOPMENTAL SKILL	RATING (1-5)
Physical	★★★★★
Cognitive	★★★★★
Social/Emotional	★★★★★
Sensory	★★★★★
Communicative	★★★★
www.ableplay.org	
Play products for children of all abilities Independent evaluation by National Lekotek Center	

**Play Value:**

- ★ The convex and concave surface design creates different heights for strengthening children's movement, balance and coordination.
- ★ Children can participate in building up their tactile routes and placing their favorite materials in the tactile bag to enhance the tactile experience.
- ★ By creating various possible routes, children can develop their action planning skills and adaptive motor skills.
- ★ The concept of the textured path and the container offer numerous tactile experiences and stimulation.

# KT0012 Weplay Balance Stepping Clouds



Age: 3 y+  
Components:  
Cloud x 4 (blue x 2, green x 2) -  
23.7 x 31.5 x 4.5 cm (L x W x H)  
Carrying Bag x 1  
Maximum load: 80 kg

INT'L PAT 3 y+



**Product Feature:**

- ★ The textured surfaces with two different patterns offer various levels of tactile sensory intensity.
- ★ The inflatable Balance Stepping Clouds with hard and soft sides create the platform for experiencing dynamic balance.
- ★ Designed with different colors and patterns, Weplay Balance Stepping Clouds can be used to create various routes with different levels of challenges.



**Play Value:**

- ★ Balance Stepping Clouds offers the most suitable tactile sensory intensity.
- ★ The activities with the Balance Stepping Clouds can improve dynamic balance skills and enhance physical coordination.
- ★ Children can develop action planning skills and spatial awareness concepts through creating their own paths.
- ★ It helps to improve children's confidence and agility when they jump from one Cloud to another.



# KT0009-00B, KT0009-00G Wavy Tactile Path



Age: 1 y+  
Components:  
Wavy Tactile Path x 8, Carrying Bag x 1  
KT0009-00B: light blue x 4, blue x 4  
KT0009-00G: light green x 4, green x 4  
Maximum load: 80 kg

INT'L PAT

1 y+

TAIWAN EXCELLENCE  
GOLD AWARD 2010



### Play Value:

★ This set is non-directional and can be arranged into curvy or linear routes to provide children with multiple ways of playing. The wavy slopes are ergonomically designed to aid balance, movement, coordination and tactile perception.

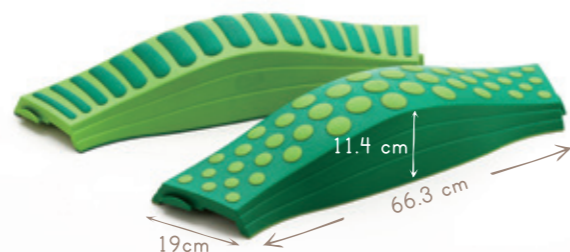

Carrying bag



The slope is ergonomically designed to match with the arches of the foot. Children can stretch the muscles and release tensions of their feet. This design is helpful for children with flat feet.



KT0009-00G + KT0008 + KT0010

Walking on the circular pattern over and over again helps children understand the center of gravity of their bodies.



### Product Feature:

- ★ The tactile pattern is molded through the entire product, acting as a tactile surface on the top and anti-slip grip on the bottom.
- ★ The protruding textures on the top stimulate children's soles and help physical development.
- ★ The design of Wavy Tactile Path challenges the users. They have to keep their balance and shift their center of gravity while walking on the long path.
- ★ Wavy Tactile Path is stackable for easy storage.



KT0009-00G + KM1002



KT0009-00B

## KT0010 Connector

Components:  
Connector x 6 - 18 x 7 x 4 cm (L x W x H)

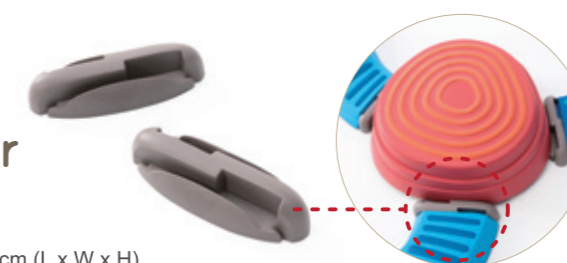

- ★ The Connector is to link Wavy Tactile Path and Rainbow River Stones.
- ★ Each Rainbow River Stone requires 3 Connectors to keep it stable.

ableplay RATING	
serial #WBL-TP07-0801-09	
Weplay Wavy Tactile Path	
DEVELOPMENTAL SKILL	RATING (1-5)
Physical	★★★★★
Sensory	★★★★★
Cognitive	★★★★★
Social/Emotional	★★★★★
Communicative	★★★★
www.ableplay.org	
Play products for children of all abilities Independent evaluation by National Lekotek Center	

# KT0008 Rainbow River Stones



Age: 2 y+  
Components:  
Red River Stone (L) x 2  
Green River Stone (M) x 2  
Yellow River Stone (S) x 2  
Carrying Bag x 1  
Maximum height: 29 cm  
Maximum load: 80 kg

INT'L PAT 2 y+



Carrying bag

Rotate to create different slopes



KT0008 + KT0009-00B



KT0008 + KT0009-00G + KT0010+  
KM1001 + KM1002

**Product Feature:**

- ★ Rainbow River Stones includes three different sizes. The set is designed for multiple freestyle route designs.
- ★ Each size of the stone has a different slope. Different slopes can be created by stacking the stones at different angles. Using the stones individually creates various challenges for children.
- ★ The dotted, lined and circular patterns on the surfaces provide different tactile experiences.
- ★ The center of each stone is slightly elastic, which provides a cushioning effect when children jump from one stone to another.
- ★ Anti-slip surface and bottom edge offer the best stability and safety.
- ★ The carrying bag included offers easy storage and convenient portability.

**Play Value:**

- ★ Children's motor skills and balance coordination can be developed through the activities with Rainbow River Stones.
- ★ Playing Rainbow River Stones barefooted provides tactile experiences to the soles.
- ★ By arranging the Stones into different routes, children can enhance their action planning skills with those different routes.
- ★ Children's self-confidence, reaction capability, and learning ability can be improved through the activities.
- ★ Rainbow River Stones helps children adapt to various surfaces and environments.

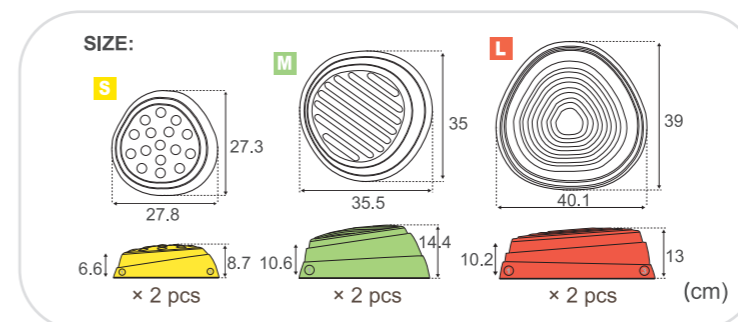

able play RATING	
Weplay Weplay Rainbow River Stones	
serial #VWEBL-RS01-0625-08	
DEVELOPMENTAL SKILL	RATING (1-5)
Physical	★★★★★
Sensory	★★★★★
Communicative	★★★★★
Cognitive	★★★★★
Social/Emotional	★★★★★

www.ableplay.org

Play products for children of all abilities  
Independent evaluation by National Lekotek Center

# We-Blocks

We-Blocks consist of 4 items, KT1001~KT1004, each set is compatible with the others. We-Blocks are easy to assemble and disassemble.

## KT1001 Tactile Cube

Age: 6 m+  
Maximum load: 50 kg

INT'L PAT 6 m+

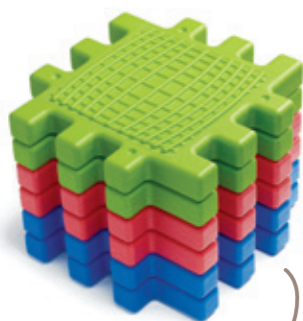

Stackable for easy storage

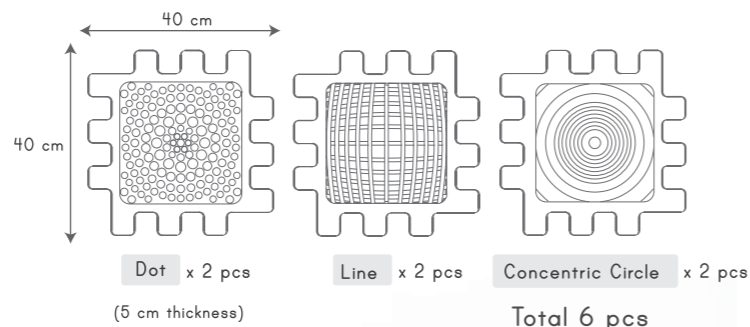

**Product Feature:**

- ★ Dotted, lined and circular patterns provide children different tactile stimulations.
- ★ Anti-slip dots on the bottom of the blocks ensure safety.

**Play Value:**

- ★ Tactile Cube provides hands and feet different tactile experiences.
- ★ Different patterns on the surface enhance children's tactile sensitivity.
- ★ Various straight and curved configurations improve children's spatial and directional concepts.



## KT1002 Reflector Cube

Age: 6 m+

INT'L PAT 6 m+

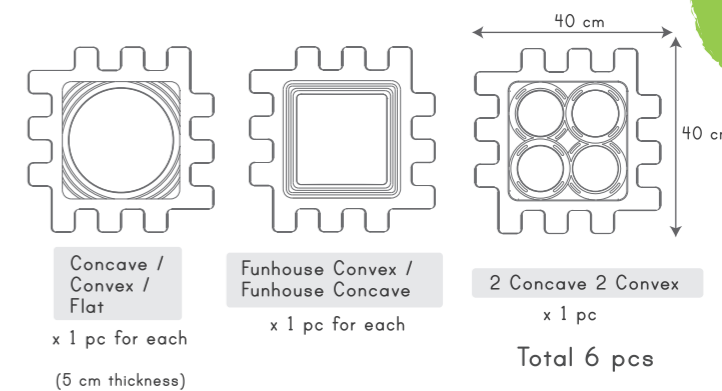

**Product Feature:**

- ★ 6 different types of mirrors provide interesting visual images such as concave, convex and funhouse.
- ★ Made with safe, durable and high-quality mirrors, the blocks can be used either individually or combined with the others. Reflector Cubes can be leaned against the wall or combined into 3D cubes, which are suitable for toddler's activity spaces.

**Play Value:**

- ★ The different types of distortion created by the curved mirrors (e.g., faces appear extremely wide or narrow) satisfy children's desire of looking in the mirrors, curiosity and visual exploration.
- ★ Reflector Cube helps children learn the basic concept of reflection.

able play RATING	
serial #WEBL-BS03-0801-09	
Weplay We Block Series	
DEVELOPMENTAL SKILL	RATING (1-5)
Sensory	★★★★★
Communicative	★★★★★
Cognitive	★★★★★
Social/Emotional	★★★★★
Physical	★★★★★
www.ableplay.org	
Play products for children of all abilities	
Independent evaluation by National Lekotek Center	



Easy to assemble and take apart



# KT1003 Construction Tower

Age: 2 y+

2 y+

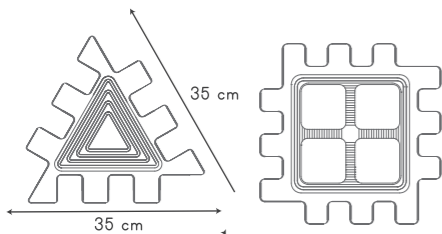

Triangle x 4 pcs

Square Window x 2 pcs

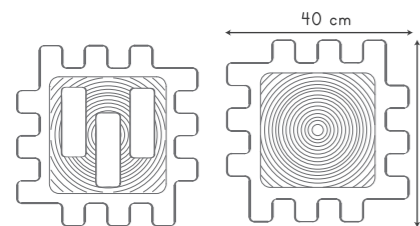

Rectangular Window x 2 pcs

Solid Square x 4 pcs

Total 12 pcs

(5 cm thickness)



**Product Feature:**

- ★ Blocks in 4 different shapes and colors can be constructed into a colorful and big-scale construction.
- ★ Square Window blocks, Rectangular Window blocks and Triangle blocks provide the blocks with the elements such as penetrating visual perception and narrative stories. Construction Tower perfectly combines block construction and role-playing games.
- ★ Sturdy and lightweight material makes it easy to assemble for children.

**Play Value:**

- ★ Large constructive games promote children's sensory motor integration.
- ★ The blocks enhance children's visual, spatial and observation abilities.
- ★ Children are encouraged to explore different shapes and spaces.
- ★ Playing Construction Tower cultivates children's design and execution abilities.



2 sets

2 sets

# KT1004 Gears

Age: 2 y+



2 y+

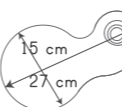

Handle x 2 pcs



Small Gear x 4 pcs

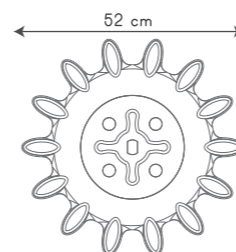

Large Gear x 2 pcs

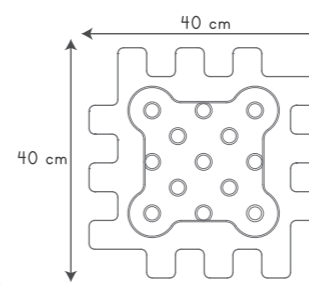

Panel x 6 pcs

Total 14 pcs



FINGER ENTRAPMENT  
RISK-FREE

**Product Feature:**

- ★ Both small and large gears can be fitted on the panels. It is convenient for children to connect the gears.
- ★ Handles fit both small and large gears. They make the gears turn more smoothly.
- ★ Anti-slip dot design can prevent slipping on the floor. The round edge design of the panels ensures safety.

**Play Value:**

- ★ Gears help children learn the basic concept of gear transmission.
- ★ Creative play with no limit covering 2D and 3D constructions encourages children to create and discover with this gear set.
- ★ Children enhance their gross motor skills and body coordination when moving, assembling and dismantling the gears.



Singular set: Observe the single gear turns

Tactile Cube, Reflector Cube, Construction Tower and Gears can be combined for more creations. The colorful blocks allow children to use their imagination and creativity.



Combination:



KT1001 + KT1002 + KT1003 + KT1004

KT1001 + KT1003



KT1001 + KT1002 +  
KT1003 + KT1004

KT1002 + KT1003 + KT1004



KT1001 + KT1002 + KT1003 + KT1004



KT1001 + KT1002 + KT1003 + KT1004



KT1001 + KT1002 + KT1003 + KT1004

# KT2001-00B, KT2001-00C Sand & Water Table

Age: 1 y 6 m+  
Dimensions: 89 x 63 x 44~58 cm (L x W x H)  
Maximum load: 50 L

INT'L PAT 1y6m+



KT2001-00B

Adjustable height

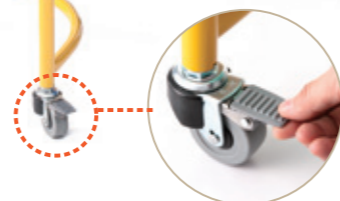

Locking caster, no finger-trap

**Product Feature:**

- ★ The locking casters are attached to the front of the stand for easy transport.
- ★ Table height is adjustable.
- ★ The tub can be easily lifted out for cleaning.
- ★ The lid can be used as a writing or drawing surface when filled with sand, or as a storage shelf when placed on the rack underneath the tub.
- ★ Water flow can be controlled by the drain plug. The plug can be removed for faster draining.



KT2001-00C

Adjustable water flow



Easy to move



**Play Value:**

- ★ It is designed for a variety of sand play activities, such as role play, encouraging children's creativity and imagination.
- ★ Sand and water play encourages sensory stimulation.
- ★ The Sand & Water Table provides exploration opportunities and allows children to explore different textures.
- ★ The large size is ideal for children to share and interact with peers.

able play RATING	
Weplay serial #VVEBL-WT05-0801-09	
Sand & Water Table	
DEVELOPMENTAL SKILL	RATING (1-5)
Sensory	★★★★★
Communicative	★★★★★
Cognitive	★★★★★
Social/Emotional	★★★★★
Physical	★★★★

www.ableplay.org

Play products for children of all abilities  
Independent evaluation by National Lekotek Center



KT2001-00C



KT2001-00B





# KT3001-003 Weplay Twister

Age: 3 y+  
Dimensions: Ø 15 cm, thickness 3 cm

3 y+



3 levels of resistance in 3 colors, 1 piece of each

**Product Feature:**

★ Three levels of resistance allow users to enhance their grip strength step by step.

**Play Value:**

- ★ Holding, squeezing, and twisting Weplay Twister can strengthen hand and wrist muscles.
- ★ The product is ideal for improving the flexibility of radiocarpal joints.
- ★ The tactile surface enhances the sense of touch.
- ★ Holding, pressing, and twisting Weplay Twister can help stabilize emotion.



**Twist**

Use hands to twist Weplay Twister and hold for 5-10 seconds then release slowly. Repeat this move 5-6 times. This exercise will increase the strength of wrists.

**Tap**

Hold Weplay Twister with one hand. Use it as a massage tool against arms, shoulders and legs. This could help to improve blood circulation and relieve muscle tension.

**Go around**

Hold Weplay Twister with both hands to receive tactile input and relieve stress.



# KT3002-006 Weplay Squeezer

Age: 6 m+  
Dimensions: Ø 6.5 cm, thickness 1.3 cm

6 m+



3 levels of resistance in 3 colors, 2 pieces of each

**Product Feature:**

★ Three levels of resistance allow users to progressively strengthen their grip and the muscles in their hands and wrists.

**Play Value:**

- ★ Holding, squeezing, and twisting Weplay Squeezer can help strengthen hand and wrist muscles.
- ★ Weplay Squeezer can be used to improve the flexibility of wrist joints.
- ★ The dots on the Squeezers provide hands and fingers excellent massage.
- ★ Using Weplay Squeezer helps to stimulate fingertips and improve blood circulation.



Ask the user to define different levels of resistance of the Squeezer.

Turn the Squeezer slowly with thumb and forefinger to improve finger coordination.

Hold the Squeezer as shown in the picture. Squeeze it with both hands, hold it for a few seconds and then release. This exercise is designed to improve the peripheral circulation and to strengthen the fingers.



**Squeeze**

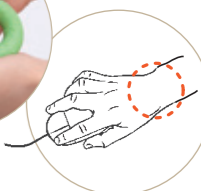

**Cleaning instruction:**

1. A mild detergent may be used to clean and sanitize. Avoid harsh detergents and bleach.
2. Dry in the shade or with a clean cloth.



# KT5001 Sound Block

Age: 3 y+  
Components:  
Block x 16 - 5 x 5 x 5 cm (L x W x H)

3 y+ STEAM Jr.



**Product Feature:**

- ★ 7 different materials are included in the set to make different sounds.
- ★ The blocks can be paired according to the materials inside, making them ideal for sound matching or memory games.
- ★ The set includes two empty blocks bringing silence.
- ★ The box come with the product makes storage easy.

**Play Value:**

- ★ Children can use the Sound Blocks to play a visual matching game.
- ★ Sound Block offers fun hearing games such as recognizing and memorizing different sounds.
- ★ Sound Block is a good aid for developing a keen sense of hearing, which in turn contributes to learning language and music.

**Sound Spectrum Analysis** Different materials create different sounds on the spectrum and offer various hearing stimulations.

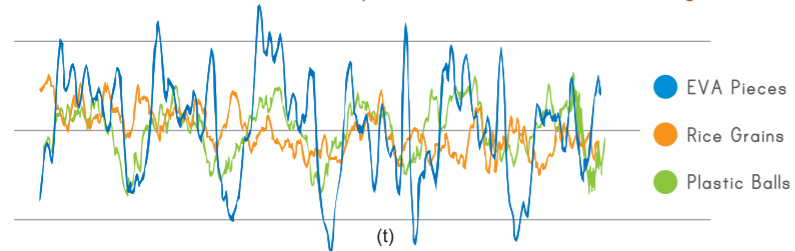

# KT0001.1, KT0001.1-002 Stepping Stones



Age: 3 y+  
Components:  
KT0001.1: Stepping Stone x 3 pairs  
KT0001.1-002: Stepping Stone x 1 pair  
Dimensions: 16 x 10.5 x 8 cm (L x W x H)  
Maximum load: 60 kg

INT'L PAT 3 y+ able play

**Description:**

The Stepping Stones have a rubber anti-slip design and the ropes are adjustable. Once the ropes are removed, the Stepping Stones can be used for balance training on either side.



Stepping Stones (without ropes)

able play RATING	
serial #WEPL-SS13-1101-15	
Weplay Stepping Stones	
DEVELOPMENTAL SKILL	RATING (1-5)
Physical	★★★★★
Sensory	★★★★★
Cognitive	★★★★★
Social/Emotional	★★★★★
Communicative	★★★★

www.ableplay.org  
 Play products for children of all abilities  
 Independent evaluation by National Lekotek Center



## KT0004.1 Tactile Straight Path

Age: 2 y+  
Components:  
Straight Path x 8 - 47.9 x 13.5 x 7 cm (L x W x H)  
Maximum load: 80 kg

INT'L PAT 2 y+

**Description:**  
Tactile Straight Path can be arranged into different routes. The textured surface with protruding dots and lines stimulate children's tactile perception.



KT0004.1



Anti-slip dots ensure the path to stay in place while in use.



KT0005.1

## KT0005.1 Tactile Curve Path

Age: 2 y+  
Components:  
Curve Path x 8 - 49.9 x 17.4 x 7 cm (L x W x H)  
Maximum load: 80 kg

INT'L PAT 2 y+

**Description:**  
Tactile Curve Path can be assembled in many ways. The textured surface with protruding dots and lines stimulates children's feet and enhances their balance coordination ability.



KT0004.1

KT0005.1

## KT0003.1 Tactile Path

Age: 2 y+  
Components: Curve Path x 8, Straight Path x 8  
Maximum load: 80 kg

INT'L PAT 2 y+



This Tactile Path can be arranged into different routes.

## KT0002.1-020 Tactile Path + Square

Age: 2 y+  
Components: Curve Path x 8, Straight Path x 8, Square Block x 4  
Maximum load: 80 kg

INT'L PAT 2 y+



## KT0004C Square Block

Dimensions: 13 x 13 x 6 cm (L x W x H)

When Square Blocks are combined with the Tactile Path, the option for four different directions is accomplished.



# KT0006.1 Rungs Way

Age: 6 m+  
 Components:  
 4 pcs (red x 1, yellow x 1, blue x 1, green x 1)  
 Dimensions: 148 x 30 x 3 cm (L x W x H)  
 Maximum load: 60 kg

6m+



**Description:**  
 Constructed of plastic sticks, Rungs Way's grooved design could stimulate the neural system and enhance the sense of touch.



Suction cups hold Rungs Way securely to the floor.



# Balance Co-ordination

The development of the cerebral cortex is crucial to children's motor coordination and learning ability. This series of auxiliary aids provides exercises that enhance children's sense of balance and coordination whilst giving them endless fun!

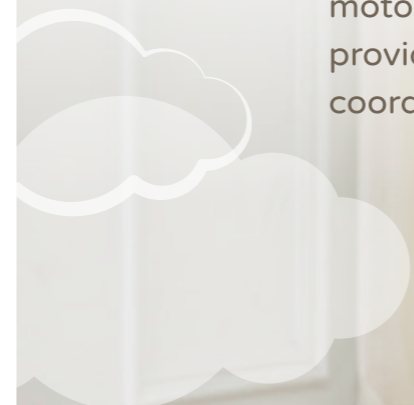

KP2006

# Weplay Rocking Leaf Boat



Age: 1 y +  
 Components: Leaf Boat x 1, Rotating Base x 1, Rocking Base x 1  
 Dimensions:  
 Leaf Boat - 72.9 × 49.8 × 21.3 cm (L x W x H)  
 Rotating Base - Ø 36.3 × 8.3 cm  
 Rocking Base - 30.2 × 28.1 × 11.9 cm (L x W x H)  
 Maximum load: 80 kg



INT'L PAT

1 y+



Multiple positions for attaching the base

**Product Feature:**

- ★ Toddlers can sit on Weplay Rocking Leaf Boat safely. It helps to soothe their emotions.
- ★ With the two bases, Weplay Rocking Leaf Boat can be used as a rotating board, a seesaw or a wobbling board.
- ★ The boat can be rotated briskly while the Rotating Base is assembled at the center of the bottom. It is fun for children to stand, sit or lie on it.
- ★ The Rocking Base can be assembled at different positions to become interesting exercise equipment.
  - Assembled on either side: The large tilting level provides children with muscular endurance practice.
  - Assembled at the center: The increased rocking level challenges children's balance control.
- ★ The design of the two raised sides allows children to grip while they are sitting on the boat. It ensures safety and stability.
- ★ The bottom of the bow and the stern are designed with grooved edges for gripping. This prevents children from finger-trapping while they are lying on the rocking boat.



The raised sides enhance the stability.

From gentle wobbling to swift tilting

**Play Value:**

- ★ Two designs of the bases provide vestibular stimulations such as rotating and multidirectional wobbling.
- ★ Children learn to adjust the center of gravity when swaying or rotating the leaf boat.
- ★ The concentration and muscle strength are promoted while children are walking or crawling across the rocking boat.
- ★ Lying on the tilting boat promotes children's upper back muscle tone and core muscle endurance.
- ★ Weplay Rocking Leaf Boat features a lovely design and a wide range of playing options from gentle wobbling to swift tilting. This gradually promotes children's adaptability and acceptance of vestibular activities.



The buffer design



More ways to play

# KP2005 Weplay Rocky Hill



Age: 2 y+  
Components: Hill x 1, Base x 1  
Dimensions with Base: 86.3 x 78 x 25.6 cm (L x W x H)  
Maximum load: 80 kg

INT'L PAT 2 y+

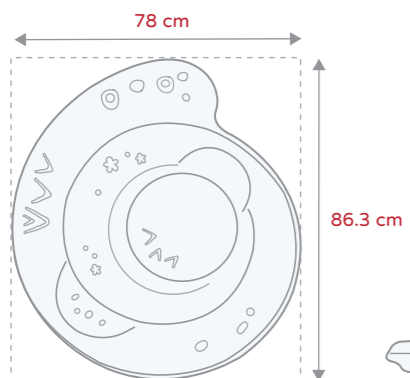

Base



Hill

The Base can be detached to make the Hill more stable. It is more suitable for toddlers to play!

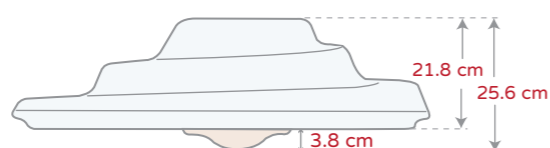

### Product Feature:

- ★ Rocky Hill is a balance board which can be walked on. On the spiral-shaped way to the summit, children have to be careful of the Rocks while the Hill is tilting forward and backward.
- ★ A total of three layers are designed for the Hill. It tilts to different slopes when children put their feet on the different layers. Children have to adjust themselves to maintain balance while playing.
- ★ Children can sit or lie on the Hill to wobble and rotate. This provides vestibular input for children.
- ★ The jumbo size of Rocky Hill can accommodate two children to play together. It is a perfect platform for children to practice shifting their weight while building teamwork skills.
- ★ The Hill can be used without the Base. It serves as a stable stepping route, a circular path and a rocky hill for toddlers to step over.

Rocky Hill is a balance board which can be walked on.



### Play Value:

- ★ Children learn to shift and maintain the center of gravity while walking on the three-layer track.
- ★ Walking on the spiral-shaped track enhances children's spatial concepts and concentration.
- ★ Maintaining balance while stepping over the wobbling Hill promotes vestibular development and motor coordination.
- ★ Playing Rocky Hill strengthens children's core muscles.
- ★ It helps children learn communication and teamwork skills while two children play Rocky Hill together.



# KP5003 Weplay Helix Balance Path



Age: 3 y+  
Components:  
Base x 1 - 51.2 x 25.8 x 17 cm (L x W x H)  
Path x 1 - 95 x 41.2 x 27.5 cm (L x W x H)  
Maximum load: 60 kg

INT'L PAT

3 y+



### Anti-slip design



The rippled pattern provides a better grip.

Two ends are inclined in opposite directions!



### Different challenging levels: (cm)

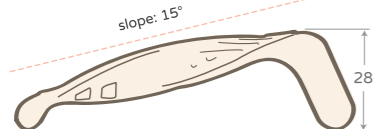

Basic height, moderate slope

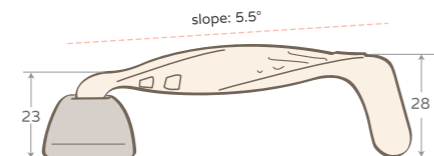

Greater height, minimal slope

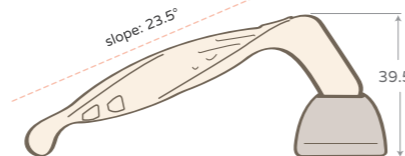

Greatest height, steepest slope

### Product Feature:

- ★ The Path with a special twisted design, makes the two ends inclined in opposite directions.
- ★ Weplay Helix Balance Path has no flat sides. The design creates challenges for children when they climb up and come down, which requires their attention and focus.
- ★ Alternating the position of the Base creates three different heights and slopes.
- ★ The ripple pattern not only offers sensory input to feet but also provides a better grip while walking on the Path.
- ★ The Base can be placed underneath the Path for easy storage.



2 sets

### Play Value:

- ★ The twisted design offers various activities while developing spatial awareness and adaptability.
- ★ Walking on the Helix Balance Path with three different heights helps to strengthen children's lower body control and balance skills.
- ★ Stepping over the Path improves children's body awareness and increases concentration.



3 sets



3 sets



2 sets



3 sets



Age: 2 y+  
Components:  
Butterfly x 6 - 48 x 31.6 x 8 cm (L x W x H)  
Rope x 1 - 350 cm (L)  
Maximum load: 60 kg

INT'L PAT 2 y+



Anti-slip patterns

With the Rope connecting Butterflies, it is easy to move the Weplay Butterfly Path to create various configurations.

**Product Feature:**

- ★ Weplay Butterfly Path has two sides that provide different wobbling experiences. One side moves up and down like a seesaw while the other side wobbles gently with the arc base.
- ★ With wider forewing and narrower hindwing, children need to focus on their footsteps while walking on the path.
- ★ It is easy to create straight, curved or circular paths with the Rope connecting Butterflies. Weplay Butterfly Path offers flexible configurations.
- ★ Butterflies can also be placed individually without the Rope. It offers more possibilities for changing distance and wobbling direction.
- ★ The anti-slip pattern is beautiful and functional, it ensures safety while playing.



Weplay Butterfly Path has two sides that provide different wobbling experiences.



2 sets

**Play Value:**

- ★ Two different ways of wobbling challenge balance skills and reaction time.
- ★ With wider forewing and narrower hindwing, children need to focus on their footsteps while walking on the path. It offers a platform for children to practice bilateral coordination.
- ★ Butterflies can be connected with the rope or placed individually. The various configuration creates more activities which include practicing distance estimation and concentration.



A Butterfly can be placed individually!

2 sets



# KE0011-00B, KE0011-00S Weplay Rocking Volcano



Age: 3 y+  
Dimensions:  
Bottom Ø 35.7 cm x 30 cm (H),  
Top Ø 26.2 cm  
Maximum load: 60 kg

3 y+

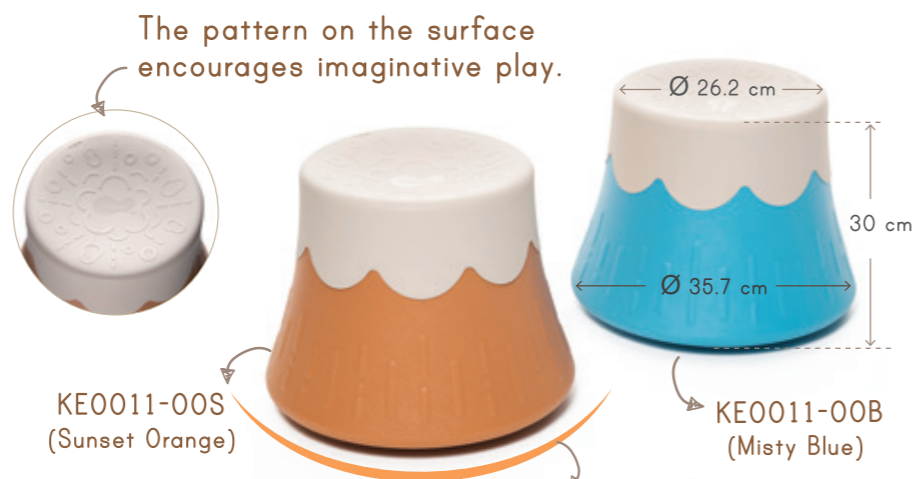

KE0011-00S  
(Sunset Orange)

KE0011-00B  
(Misty Blue)

The arc-shaped bottom allows for movements in all directions.

**Product Feature:**

- ★ Rocking Volcano is designed with the look of a volcano. It has an arc-shaped bottom, which allows for movements in all directions.
- ★ Rocking Volcano transforms conventional sitting into a fun activity by providing an outlet for children to move around while remaining seated.
- ★ Swinging and rotating the Rocking Volcano while maintaining body balance helps children regulate emotions and build muscles.
- ★ A comfortable and concave seat naturally guides children to a proper sitting position. The pattern on the surface encourages imaginative play.
- ★ It is also suitable for adults! The movements help users loosen tight muscles from excessive sitting.



**Play Value:**

- ★ Continuously moving and sitting promote core strength and improve concentration.
- ★ Spinning around while sitting on the Rocking Volcano encourages vestibular input and develops better balance.



Children engage their core muscles to maintain stability while sitting in proper posture. This offers an active sitting practice!



Age: 2 y+  
 Components:  
 Large Ice x 2 - 44.7 x 44 x 18.6 cm (L x W x H)  
 Medium Ice x 2 - 27.4 x 25.6 x 11.6 cm (L x W x H)  
 Small Ice x 2 - 24.9 x 20 x 10.8 cm (L x W x H)  
 Maximum load: 60 kg

2 y+



Three levels of balance activities



**Product Feature:**

- ★ Three sizes of Ice with irregular shapes provide different widths for children to step on when being placed in various directions.
- ★ Each size of Ice has a different design of the bottom. Each features a unique challenge for children including walking stably, wobbling as well as rocking back and forth. It is as if children are walking on ice floating in the ocean.
- ★ The flat, v-shaped concave, and dented tops of Ice match with the designs of the bottom, making it easier for children to coordinate their vision and physical sensibility.
- ★ The anti-slip patterns include snowflakes, penguin footprints, and fish. The designs not only attract children to the activities but also provide various tactile experiences.
- ★ Large Ice can be used as a rocking stool, on which children can either stand or sit. It's also great for toddlers to use.
- ★ The anti-slip bottom ensures safety for children walking on Ice.



Irregular Ice with anti-slip pattern on the top!



The Medium and Small Ice can be stored in the Large Ice.



KP4005 + KP5003

KP5002

# Weplay Nesting Balance Path



Age: 1 y+

Components:

Elephant Path (brown) × 2 - 66.4 × 36.7 × 17.2 cm (L × W × H)

Cat Path (green) × 1 - 112.9 × 26.3 × 12.7 cm (L × W × H)

Duck Path (orange) × 1 - 105.1 × 16.1 × 7.9 cm (L × W × H)

Frog Path (yellow) × 1 - 97.6 × 6.6 × 4.2 cm (L × W × H)

Maximum load: 60 kg

INT'L PAT

1 y+

Storage Dimensions:

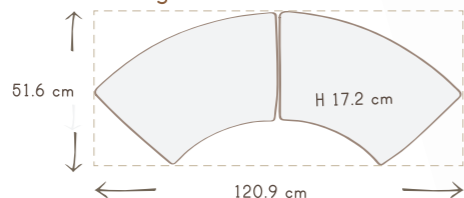

Anti-slip design



Elephant



Cat



Duck



Frog

Different patterns on each board

### Product Feature:

- ★ Created with four different widths and heights, the Nesting Balance Path can be nested for length adjustment to cater to each age group's abilities for balance games.
- ★ The Nesting Balance Path can be configured as circles, twists and turns, which determine the directions of the paths.
- ★ The special design of the Elephant Paths can create layered stairs and make various twists and turns.
- ★ To enrich path configurations and activities, the Nesting Balance Path can be set as traverses for crawling or stepping over.
- ★ The four patterns of footprints on the convex surfaces simulate animals strolling along the paths, adding more fun while children are playing.
- ★ The Nesting Balance Path can be nested for easy storage.



### Play Value:

- ★ Walking on the Nesting Balance Path with different widths, heights, curved and convex surfaces enables children to feel their center of gravity and learn to keep their balance.
- ★ The four heights of the Nesting Balance Path help to increase children's single-leg strength and stability.
- ★ The four widths of the Nesting Balance Path create challenges to children's adaptation to narrow and bumpy roads.
- ★ Children's distance prediction abilities and full-body mobility can be improved by crawling or stepping over the path in a crisscrossed setting.
- ★ The four patterns of animal's footprints on convex surfaces offer sensory inputs and stimulation to feet and eyes.

KP5002 + KP2005

2 sets



# KP5001 Weplay Jungle Trial



Age: 2 y+  
Components:  
Base x 4 - 46.8 x 19.8 x 18.7 cm (L x W x H)  
Log x 6 (green x 3, light brown x3) -  
58.7 x 13.8 x 9.2 cm (L x W x H)  
Maximum load: 60 kg

INT'L PAT

2 y+



Different patterns on each side of the board

### Product Feature:

- ★ Jungle Trial is inspired by a forest path. The Logs are flat on one side and convex on the other, which gives children different challenges when they are walking on it.
- ★ One side of the Logs is a growth ring pattern, while the other side is a flower and leaf pattern. The patterns provide different sensory inputs to feet.
- ★ The Logs can be placed above or underneath the Bases to create different heights, enriching path configurations and activities.
- ★ Two Logs can be placed on the Bases to create a track, while one Log creates a single-log bridge.
- ★ The Bases are safe and stable obstacles to step over. There are multiple ways to play Jungle Trial.



Anti-slip design



2 sets

Jungle Trial helps children strengthen their movement, balance and coordination skills.



2 sets

2 sets



Step over the Bases

### Play Value:

- ★ Walking on the balance path enables children to feel their center of gravity and learn to keep their balance.
- ★ Activities with Jungle Trial improve body movement, coordination and stability.
- ★ Configurations with the paths up and down build children's single-leg strength.
- ★ Jungle Trial creates paths with flat and convex surfaces, providing different levels of activities.
- ★ Children's movement, balance and coordination are strengthened through games created with the Jungle Trial.
- ★ Stepping over the Bases improves children's distance prediction abilities and strengthens hip joint mobility.

# KP1005-00B, KP1005-00S Weplay Whally Board



Age: 1 y 6 m+  
Dimensions: 62 × 39,5 × 17 cm (L x W x H)  
Maximum load: 60 kg

INT'L PAT 1y6m+

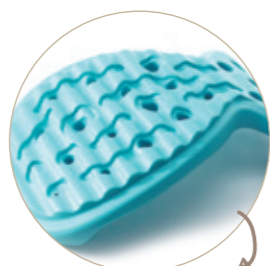

3D wavy base



**Product Feature:**

- ★ Whally Board design is inspired by the image of fish jumping out of the water. The wave and bubble patterns on the textured surface stimulate the feet and hands while adding grips to protect children from slipping.
- ★ Whally Board provides optimum comfort and prevents stress or injury while children rock on it. Children can either sit or stand on it when they are playing.
- ★ The grooved edge of the back is designed to prevent finger trapping injuries.
- ★ The 3D wavy design offers tactile sensations and auditory feedback while making the activity more challenging.



KP1005-00S

KP1005-00B



More ways to play

**Play Value:**

- ★ The top side of the Whally Board allows children to practice gross motor skills such as balance and coordination. It also promotes core strength.
- ★ Children receive tactile stimulation on their feet and hands while they are playing.
- ★ Rocking sideways or backwards and forwards provides sensory stimulation and encourages vestibular input.
- ★ The Whally Boards can be used as a creative stepping route to help develop children's adaptive motor and protective reaction skills.

ableplay RATING	
serial #WEPL-WB11-0801-15	
Weplay Whally Board	
DEVELOPMENTAL SKILL	RATING (1-5)
Physical	★★★★★
Cognitive	★★★★★
Social/Emotional	★★★★★
Sensory	★★★★★
Communicative	★★★★

www.ableplay.org

Play products for children of all abilities  
Independent evaluation by National Lekotek Center

# KP2004-00C, KP2004-00G Weplay Rocking Bowl



Age: 6 m+  
Dimensions: Ø 70.6 cm, depth 31 cm  
Maximum load: 60 kg



**Product Feature:**

- ★ The bottom is designed with a smooth curve to ensure safety.
- ★ The rippled lines inside the Bowl act as an anti-slip function.
- ★ The large size makes the product suitable for one or two children.
- ★ The wavy edge allows air circulation when the Bowl is turned upside down.
- ★ Weplay Rocking Bowl can be used upside down for stretching exercises.



KP2004-00G

Rippled lines create an anti-slip bottom.



KP2004-00C



KP2004-00G

Wavy edge allows for air circulation.



KP2004-00C



KP2004-00C

KP2004-00G

Smoothly curved bottom for safety



KP2004-00G

It's a car! It's a boat! The Rocking Bowl can be filled up with small balls, stuffed animals or anything.



Balls are not included.



KP2004-00C

**Play Value :**

- ★ Rocking Bowl enhances vestibular balance.
- ★ Gross motor coordination can be improved while playing.
- ★ Children can practice stability control.
- ★ Bowls provide proper vestibular stimulation.
- ★ Bowls promote social interaction and teamwork.



KP2004-00G



KP2004-00C

Children can lie prone or supine to practice body control on an upside-down Rocking Bowl.

ableplay <sup>®</sup> RATING	
Weplay <sup>®</sup> Rocking Bowl	
serial #WEBL-RB05-1001-13	
DISABILITY CATEGORY	RATING (1-5)
Sensory	★★★★★
Communicative	★★★★★
Cognitive	★★★★★
Social/Emotional	★★★★★
Physical	★★★★

www.ableplay.org

Play products for children with special needs  
Independent evaluation by National Lekotek Center

KP6106

# Weplay Up On Top



**Special "Soft" Material,  
Play Quietly**

Age: 2 y+  
Components: blue x 1, green x 1, orange x 1  
Dimensions: 15.5 x 15.5 x 12 cm (L x W x H)

INT'L PAT

2 y+



**Description:**

Children can place Weplay Up On Top steadily upon their heads while standing or walking. They can stack 2 or 3 pieces together based on their abilities. It helps children improve their coordination and balance. It also brings challenges to the activities.



**NEW COLOR**



**Product Feature:**

- ★ Up On Top is created with a variety of colors and expressions that work to engage children's interest in multiple ways.
- ★ The soft lightweight material reduces noise and minimizes the impact when the product is dropped on the floor.

**Play Value:**

- ★ Placing Weplay Up On Top on the head raises the awareness of physical position.
- ★ While walking with Weplay Up on Top on the head during the activities, children learn to keep their physical posture upright.
- ★ Activities with this product strengthen children's physical balance.

**ableplay RATING** serial #VVEPL-UT15-1101-15

DEVELOPMENTAL SKILL	RATING (1-5)
Physical	★★★★★
Sensory	★★★★★
Social/Emotional	★★★★★
Communicative	★★★★
Cognitive	★★★★

www.ableplay.org  
Play products for children of all abilities  
Independent evaluation by National Lekotek Center



# KP1801, KP1803 Forest Party



Age: 6 m+  
Components: KP1801: Caterpillar x 1, Ladybug x 4  
KP1803: Mini Caterpillar x 1, Ladybug x 2  
Maximum load: 40 kg

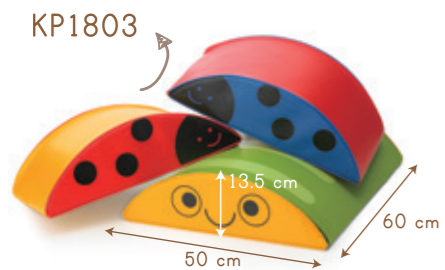

**Product Feature:**

- ★ Colorful, adorable caterpillar and ladybug designs are appealing to children.
- ★ Forest Party is designed to be used on both sides. The pieces can be placed on the flat side to create small hills or on the ridge side to become balance boards.
- ★ It is made of comfortable and durable high-density foam.
- ★ The height is suitable for children.
- ★ Forest Party is ideal for individual games and parent-child activities.

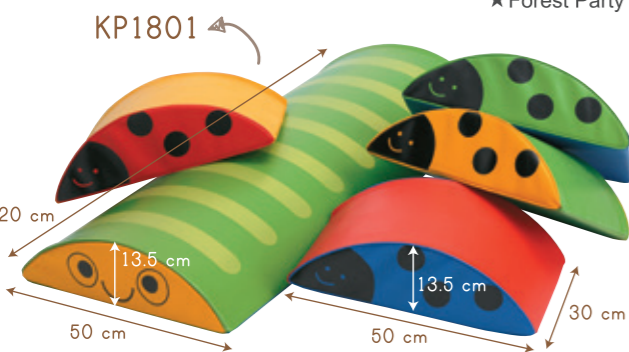

High-density form for durability



**Cleaning Instruction:**  
The surface can be easily cleaned with a damp cloth.

**Play Value:**

- ★ Children's motor skills can be developed by crawling or walking on the ridge side of Forest Party.
- ★ Children receive vestibular inputs by rocking left and right or forward and backward. This helps enhance their coordination.
- ★ For toddlers, the set can be arranged into uneven paths for advanced practices.
- ★ Using it as a rocking horse or a pirate ship in a scenario play can inspire children's imagination.



able play RATING	
serial #WEBL-FP04-0801-09	
Weplay Forest Party	
DEVELOPMENTAL SKILL	RATING (1-5)
Physical	★★★★★
Sensory	★★★★★
Social/Emotional	★★★★★
Communicative	★★★★★
Cognitive	★★★★
www.ableplay.org	
Play products for children of all abilities Independent evaluation by National Lekotek Center	





# KP6205 Weplay Taxi Roller



Age: 3 y+  
Dimensions: 52 x 47 x 62 cm (L x W x H)  
Pedal - 52 x 11 cm (L x W)  
Maximum load: 60 kg

**Description:**  
Children shift their body weight to control the pedals and move the Taxi Roller backwards or forwards. The Taxi Roller is designed for one or two children. It enhances muscle strength, coordination and movement control as well as cooperation and interaction with peers.

3 y+



Handle grips are non-absorbent, durable and easy to clean.



The wheel structure provides great durability and stability.

**Play Value:**  
★By shifting weight up and down, children can learn how to control their bodies and smoothly shift their weight.  
★Taxi Roller enhances the left-side and right-side coordination.  
★Riding Taxi Roller helps to train children's muscular strength. It builds their communication skills when riding with peers.



Suitable for two children riding together or one child riding alone



# KP6204 Weplay Pedal Walker

Age: 3 y+  
Dimensions: 47 x 36.7 x 54 cm (L x W x H)  
Pedal - 30 x 10.5 cm (L x W)  
Maximum load: 40 kg

3 y+

**Description:**  
It is a Pedal Walker for everyone! With the pedals and the detachable handrails, the Weplay Pedal Walker works like a quadricycle. When riding without the handrails, it challenges the user's advanced coordination skills.



Sturdy connections between pedals and handles are for a safer ride.



The integrated wheel structure allows for greater durability.



Handle grips are durable and easy to clean.

# KP6202.1 Twin Walker



Age: 3 y+  
Dimensions: 75.7 x 50.5 x 78.8 cm (L x W x H)  
Pedal - 66 x 19 cm (L x W)  
Maximum load: 100 kg

3 y+

Raised edges and anti-slip textures on the pedals create a safe area for feet.



**Description:**  
Twin Walker helps to build social skills and develop balance and coordination abilities during playtime! This is a unique walking platform for one or two players, either for one adult with one child or for two children.

# KP4001.1 (Circle), KP4001.1-002 (Semicircle) Go-Go Balance Fun

Age: 3 y+  
Maximum load: 60 kg

INT'L PAT 3 y+



KP4001.1

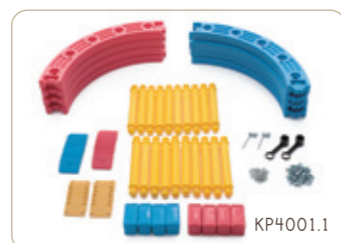

Product size (one piece):

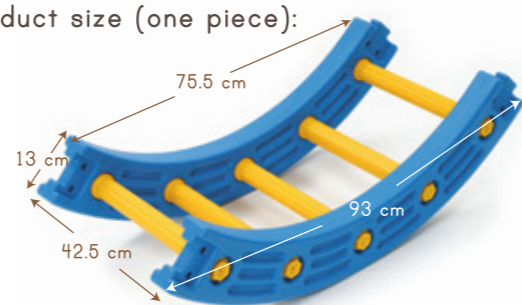

The outside diameter: 134 cm  
The inside Diameter: 108 cm

**Description:**

Go-Go Balance Fun offers many different ways to play! It is a climbing arch when set up as a semicircle. When set up as a circle and placed on its side, it becomes an advanced balance beam. It offers challenges at various levels.

**Components:**

KP4001.1 (Full circle)	KP4001.1-002 (Semicircle)
1/4 Circle x 8 (red x 4, blue x 4)	1/4 Circle x 4 (red x 2, blue x 2)
Foot Sheath x 8 (red x 4, blue x 4)	Foot Sheath x 4 (red x 2, blue x 2)
Plastic Cover x 16 (red x 8, blue x 8)	Plastic Cover x 4 (red x 2, blue x 2)
Bolt x 32	Bolt x 8
Nut x 32	Nut x 8
Plastic Board x 16	Plastic Board x 4
Yellow Rod x 20	Yellow Rod x 10
Rubber Washer x 40	Rubber Washer x 20
Plastic Nut x 40	Plastic Nut x 20

**Tool:**  
Plastic wrench (for Yellow Rods with Nuts and Washers) x 2  
Metal wrench (for Bolts and Nuts) x 2



KP4001.1

Go up, go down, make it fun!

KP4001.1-002

Please place the foot sheath on the equipment to ensure safety. It is recommended to use the product on a flat surface with a padded mat.

# KP4002 (Circle), KP4002-002 (Semicircle) Weplay Balance Arch

Age: 3 y+  
Maximum load: 60 kg

INT'L PAT 3 y+



KP4002

Product size (one piece):

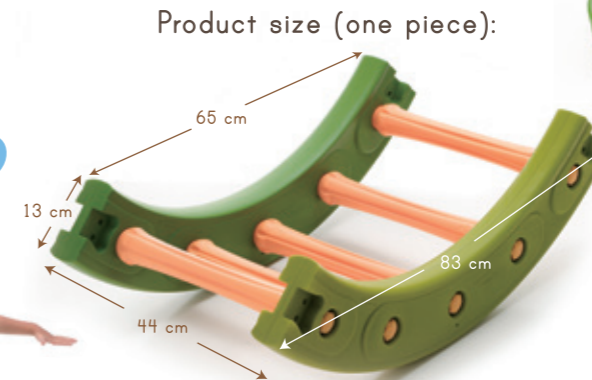

KP4002



KP4002-002

All in anti-slip material

**Description:**

Weplay Balance Arch is a fun product which can be used as an arch or combined to build paths or bridges. It is excellent for increasing body movement and training balance coordination. All parts are made of anti-slip materials and are easy to assemble.

**Components:**

KP4002 (Circle)	KP4002-002 (Semicircle)
1/4 Circle x 8 (dark green x 4, light green x 4)	1/4 Circle x 4 (dark green x 2, light green x 2)
Rod x 20	Rod x 10
Connector with Bolt x 8	Connector with Bolt x 2
Connector Cap x 8	Connector Cap x 2
Large nut (orange) x 40	Large nut (orange) x 20
Small nut (green) x 32	Small nut (green) x 8
Tool x 2	Tool x 1

The outside diameter: 118 cm  
The inside diameter: 92 cm



KP4002-002

Step by step, walk or crawl!  
Let's have fun together.

KP4002

# KP1001.1, KP1002.1 Seesaw



Age: 3 y+  
Components: Seesaw x 1, Ball x 2  
Dimensions: 50 x 23 x 10.2 cm (L x W x H)  
Maximum load: 60 kg  
Replacement ball set: KP1001B

**Description:**  
This dual function device is a combination of a seesaw and a balance board. Players need to keep the ball rolling along the track while keeping balance. Each set includes two balls.



# KP1003.1 Rocking Seesaw

Age: 3 y+  
Dimensions: 55 x 23.2 x 15 cm (L x W x H)  
Maximum load: 60 kg



**Description:**  
The Rocking Seesaw has a rubber anti-slip design on the bottom. The left-right movement promotes coordination development.



# KP0005 Putt Putt Balance Board



Age: 3 y+  
Components: Board x 1, Ball x 2  
Dimensions: 50.3 x 40.5 x 11 cm (L x W x H)  
Maximum load: 80 kg  
Replacement ball set: KP0005B



From simple to complex, challenging levels are adjustable based on the child's abilities.



Roll the ball between the upper and lower layers

**Product Feature:**  
★ Inspired by the shape of a leaf on a flower, the Putt Putt Balance Board is light green and has a double-layered track.  
★ The removable transparent track board provides an extra challenge as children's ability and confidence develop.  
★ The anti-slip design on the bottom ensures the user's safety.

**Play Value:**  
★ It helps to develop flexibility, balance and coordination as users roll the ball along the track with their hands or feet.



## KP0002.1 Circular Balance Board

Age: 3 y+  
Components:  
Board x 1 - 51 x 46 x 6 cm (L x W x H), Ball x 2  
Maximum load: 60 kg  
Replacement ball set: KP0002A

3 y+



It is an entry-level balance board for practicing coordination skills. The design of the base ensures safety while children enjoy the fun activities.

## KP2001.1 Rotator

Age: 3 y+  
Dimensions: 51 x 46 x 10 cm (L x W x H)  
Maximum load: 60 kg

3 y+



The Rotator is designed for young children. They can sit or stand on it and rotate. This is a wonderful activity for balance training.

## KP0001.1 Maze Balance Board

Age: 3 y+  
Components:  
Board x 1 - 54 x 40 x 5.4 cm (L x W x H), Ball x 3  
Maximum load: 60 kg  
Replacement ball set: KP0001B

3 y+



The Maze Balance Board is a circular (all directions) board enhancing balance coordination. The snail labyrinth, a simple but cute pattern, brings additional challenges and interest to this balance board.

## KP0004.1 (S), KP0003.1 (L) Tai Chi Balance Board

KP0004.1 (S)  
Age: 3 y+  
Components:  
Base Board (fish pattern) x 1 - Ø 48 x 7 (H) cm  
Interchangeable disk:  
2D Tai Chi pattern x 1, 3D Tai Chi pattern x 1, Ball x 3  
Maximum load: 60 kg  
Replacement ball set: KP0004B

KP0003.1 (L)  
Age: 3 y+  
Components:  
Base Board (goggles pattern) x 1 - Ø 66 x 8 (H) cm  
Interchangeable disk:  
Tai Chi pattern x 1, butterfly pattern x 1, Ball x 3  
Maximum load: 80 kg  
Replacement ball set: KP0001B



- ★ The base itself serves as a balance board. Children can stand on it while rolling the ball along the track.
- ★ Two interchangeable disks can be added for more fun and challenge.
- ★ The interchangeable disks can also be used individually as handheld toys for hand-eye coordination training.



KP0004.1



KP0003.1



## KP2003.1 Rotation Board with Handles (S)

Age: 3 y+  
Dimensions: 51 x 46 x 20 cm (L x W x H)  
Maximum load: 40 kg

3 y+

Children can sit on the board and use the handles to rotate the board. A simple and entertaining activity helps to stimulate the development of the cerebral cortex.



## KP2002.1-00B Rotation Board with Handles (L)

Age: 3 y+  
Dimension: Ø 66 x 20 (H) cm  
Maximum load: 60 kg

The Large Rotation Board with Handles allows one or two children to sit on it with hands holding the handles. The movements can be achieved by simple motions exerted from the waist and arms. This exercise helps to stimulate the development of the cerebral cortex.



3 y+

Two base mounts provide different levels of challenge.



## Fine Motor Skills Improvement

Fine Motor Skills refers to the control of finger dexterity and movements partners hand-eye coordination and brain integration. The technique and control of hand muscles (flick, grip, grasp, press and pinch) can be developed and strengthened through games and fun activities. Developing these skills through play provides the solid foundation for children to perform everyday skills such as holding pencils and using spoons and forks.



# KF0017 Weplay Elf's Hanger



Age: 2 y+  
Components:

Color Shape	Red	Yellow	Blue	Green
Shirt	2	2	2	2
Pants	1	1	1	1
Skirt	1	1	1	1
Hanger	12			

INT'L PAT

2 y+

STEAM Jr.



Scale x 1 (Base x 1, Scale Part x 3)  
Double-sided Activity Card x 9

Dimensions:

Scale - 48.8 x 11.7 x 26.8 cm (L x W x H), Hanger - 4.9 x 0.6 x 5.2 cm (L x W x H),  
Shirt - 6.3 x 1.5 x 5.3 cm (L x W x H), Skirt - 4.8 x 1.4 x 4.1 cm (L x W x H),  
Pants - 5 x 1.5 x 7.2 cm (L x W x H)

Double-sided Activity Cards

### Product Feature:

- ★ With the real-life elements and the two interesting ways to hang the clothes, Weplay Elf's Hanger can help children learn the concept of balance and inspire their curiosity and experimental spirit.
- ★ The double-sided design of the Scale makes the math and science games interesting, simple, and easy to play.
  - Notches with numbers 1 to 10: The notches marked with the numbers not only help children recognize and match numbers from 1 to 10, but also learn weight comparison between different components.
  - Protruding points: The Scale is designed with three protruding points on each end, allowing children to adjust the position of the components to achieve balance.
- ★ The clothes and Hangers are not only creative weights but also interesting building blocks that can be freely connected and stacked to create constructions. The number on the surface represents the weight, enabling children to adjust the tilt of the Scale.
- ★ The nine double-sided activity cards with various topics including 1 to 10 number recognition and matching, addition and subtraction, weight comparison, and balance experiments, help children learn basic math concept step by step.



The double-sided design of the Scale makes the math and science games interesting, simple, and easy to play.



Notches with numbers 1 to 10

Protruding points

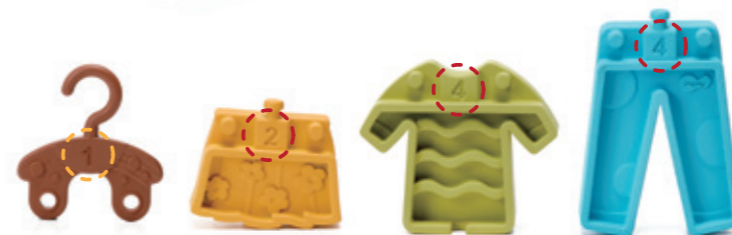

Creative weights

The numbers on the clothes and Hangers represent the weights.



Multiple ways of stacking

### Play Value:

- ★ Adjusting the position of the clothes and Hangers on the Scale enables children to learn the concept of balance and weight comparison.
- ★ The notches marked with the numbers help children recognize and match numbers from 1 to 10.
- ★ Adding and removing the clothes and Hangers assist children with learning basic addition and subtraction.
- ★ The movement of hanging the clothes and Hangers on the Scale cultivates children's fine motor and problem-solving skills.
- ★ Connecting the clothes and Hangers strengthens finger muscles and hand-eye coordination.



# KF0016 Weplay Crystal Village



Age: 2 y+

Components:

Color Shape	Color	Color	Color	Color Shape	Color	Color	Color
	4	4	4		2	2	2
	4	4	4		2	2	2

Double-sided Game Card x 6

Dimensions:

Short House Block - 2.7 x 2.7 x 5.7 cm (L x W x H)

Tall House Block - 2.7 x 2.7 x 10.5 cm (L x W x H)

90° Roof Block - 9.2 x 3 x 3.9 cm (L x W x H)

60° Roof Block - 8.7 x 3 x 6.3 cm (L x W x H)



Double-sided Game Cards



Children can understand the basic color mixing with light.

**Product Feature:**

- ★ 6 Tall Houses and 6 Short Houses make up a brilliantly colored village.
- ★ The Crystal Village offers open-ended constructive gameplay from 2D to 3D.
- ★ The basic concepts of angles are introduced through the gameplay. Tops of the House Blocks are designed as 30 and 45 degrees while the Roof Blocks are 60 and 90 degrees.
- ★ The transparent houses are in three primary colors. Crystal Village is a perfect platform for children to learn about primary colors and color mixing in a fun way. The hollow shapes as windows on the Houses create a vivid visual experience.
- ★ The Roofs come in orange, green and purple. These colors are also the result of mixing two primary colors.
- ★ The 6 double-sided game cards introduce several mathematical concepts. Children can play games independently or with game cards.

INT'L PAT



2 y+

90° Roof Block

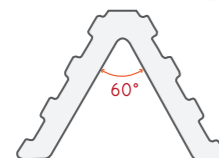
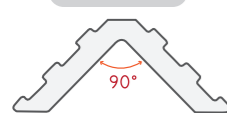

60° Roof Block

Short House Block



45°



Tall House Block



Tall House Block



Create colorful shadows with light!

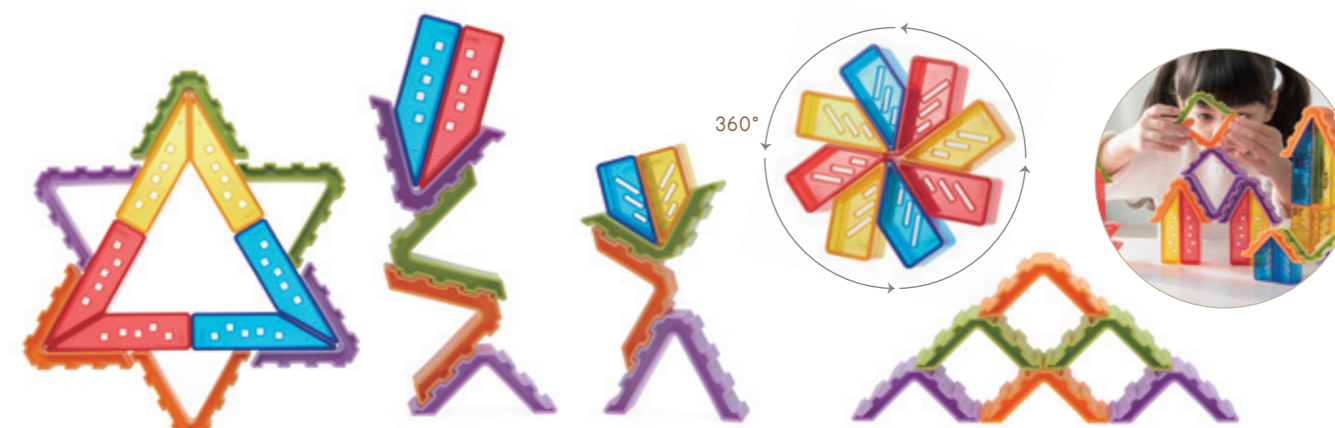

Multiple ways of stacking



**Play Value:**

- ★ From 2D to 3D construction, children's concept of structure is built systematically.
- ★ Mathematical concepts such as position, symmetry, angles, fractions and sequencing can be learned through the gameplay.
- ★ The Crystal Village helps children learn to identify and mix colors.
- ★ Construction games with the blocks in various shapes enhance children's fine motor and problem-solving skills.
- ★ The beautiful design and color scheme allow children to use their unlimited imagination and cultivate an interest in the arts.



# KF0015 Weplay Crystal Carnival



Age: 10 m+

Components:

Color Shape	Red	Yellow	Blue	White
	1	1	1	1
	1	1	1	1
	1	1	1	1

INT'L PAT 10 m+



Game Cards provide clear instructions for fun games and activities.

Base x 1

Double-sided Game Card x 6

Dimensions:

Elephant - 8.5 x 6.7 x 2 cm (L x W x H)

Fish - 7.8 x 6.2 x 2 cm (L x W x H)

Owl - 7.3 x 7.1 x 2 cm (L x W x H)

Base - 20.7 x 13.5 x 10.7 cm (L x W x H)

Product Feature:

- ★ Various geometric shapes are designed in the middle of the different creature blocks for shape matching games.
- ★ The Fish block can spin on the round post with threads like a nut on a bolt. Children can observe how the threads work through the transparent block.
- ★ Children can learn color mixing with the transparent blocks in 3 primary colors.
- ★ Transparent concepts are introduced to children with the clear blocks. The clear blocks also enrich the play.
- ★ The creature-shaped blocks can be stacked together. Different shapes create more challenges.
- ★ 6 double-sided game cards provide clear instructions for the fun games and activities.
- ★ The curved base design is unique and makes Crystal Carnival easy to store.

The Fish block can spin on the round post with threads like a nut on a bolt.



Children can understand the basic color mixing with light.

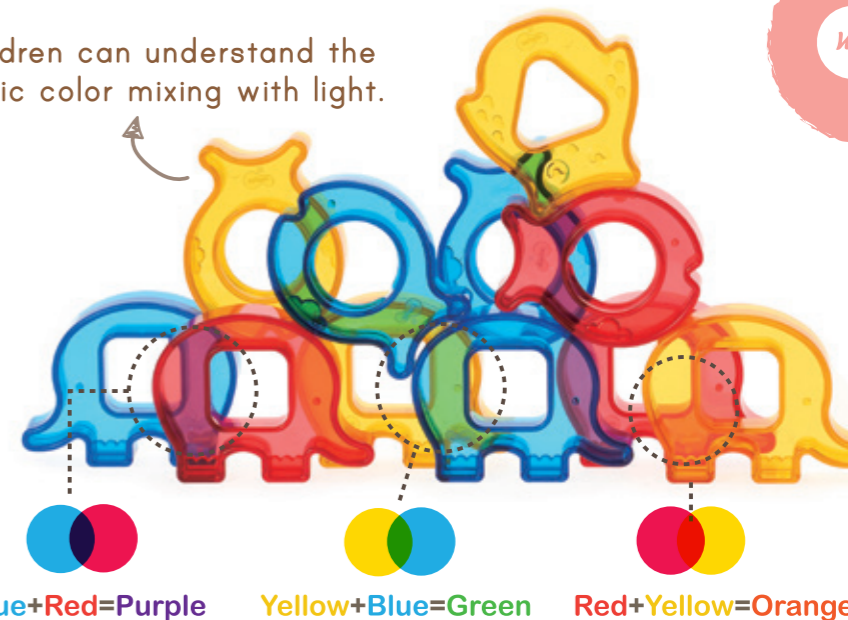

Play Value:

- ★ Children are introduced to geometric shapes while improving their hand-eye coordination.
- ★ Spinning the Fish block on the column improves self-care skills and children's wrist dexterity. Children can understand the basic color-matching with light. For example, green is made by mixing blue and yellow, purple is created with red and blue, orange is the combination of red and yellow etc.
- ★ By stacking the creatures, it enhances children's hand stability and problem-solving skills.
- ★ Children can learn matching, sequencing and shape or color identification through games with the game cards.



Imitation & creation



2 sets



# KF0013 Weplay Bean Pods



Age: 1 y+  
 Components:  
 Pod x 3 pairs  
 (green x 1, light green x 1, translucent x 1) - 18.5 x 7 x 5.3 cm (L x W x H)  
 Large Bean x 3 - Ø 5.5 x 3.7 (H) cm  
 Small Bean x 6 (yellow x 3, orange x 3) - Ø 4.5 x 2.8 (H) cm

INT'L PAT

1 y+



### Product Feature:

- ★ The size makes children feel like they are playing with a big bean.
- ★ Children can use the Pods for activities with the Beans.
- ★ The Pods can be used as a tool to move the Beans with one or both hands.
- ★ Different patterns on the Beans create greater challenges when children stack them.
- ★ Both the Pods and the Beans have three different colors selected from nature.
- ★ The hollow design adds vividness to the Pods.
- ★ The translucent green Pods bring different visual experiences and allow for even more color games.
- ★ The Pods can be used for storing the Beans when they are not in use.



Gently press the sides to open the Pods

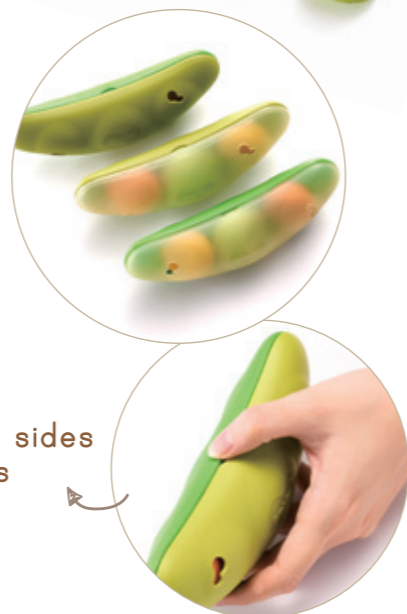

3 different resistances & tactile experiences



### Creative stacking



### Play Value:

- ★ Picking up, holding or scooping up the Beans with the Pods enhances the strength and stability of hands. These activities improve children's self-care skills.
- ★ The Pods can be reassembled with different colors. This activity enhances fine motor skills.
- ★ Grasping and stacking the Beans provide different tactile experiences while strengthening fine movements.
- ★ Children's color recognition ability can be enhanced through mixing and matching different colors of the Beans and the Pods.
- ★ Different colors, sizes and patterns offer children a wide variety of sorting games and activities.



# KF0012 Weplay Apple Links



Age: 3 y+  
 Components:  
 Apple x 20 (red x 10, green x 10) - 4 x 4 x 4 cm (L x W x H)  
 Caterpillar (S) x 20 - Ø 0.7 x 4.6 (L) cm  
 Caterpillar (L) x 20 - Ø 0.7 x 7 (L) cm  
 Needle Caterpillar x 2 - Ø 0.5 x 5.3 (L) cm  
 String x 2 - 100 cm (L)  
 Dual-colored Leaf x 20 - 3 x 2 cm (L x W)

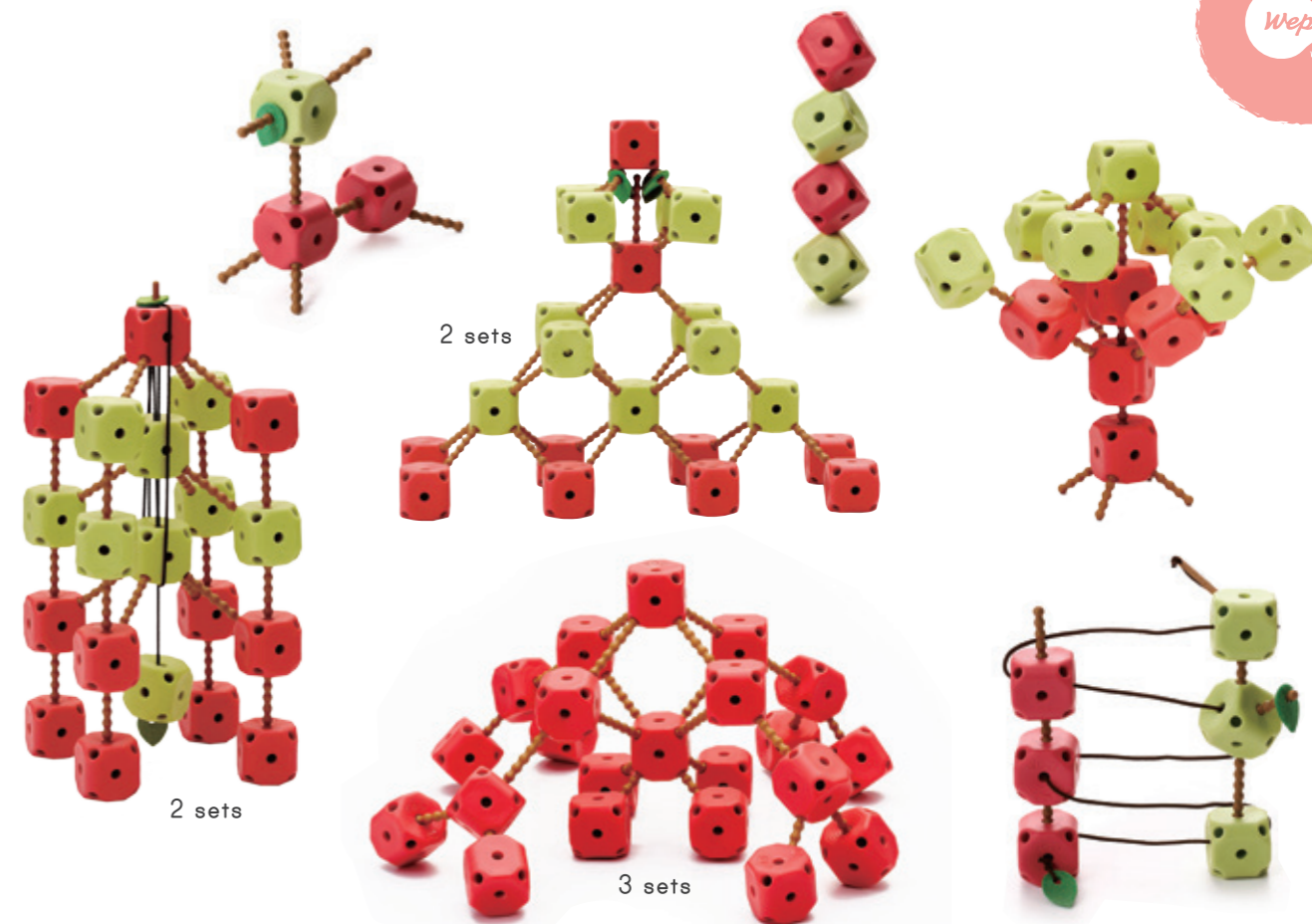

**Product Feature:**

- ★ By combining or sequencing the Apples, the Leaves, and the Caterpillars, children could challenge and enhance both finger dexterity and cognitive motor skills.
- ★ Stackable Apples provide limitless possibilities for balance games and various levels of stacking activities.
- ★ While threading the Apples and the Leaves, children could experience different textures.
- ★ The Caterpillars come in two different lengths for more versatile designs.
- ★ Threading and tying with the Needle Caterpillar provide basic training for daily self-care abilities.
- ★ The Needle Caterpillar can be used to link the Apples in different structures and make more interesting and unique creations!
- ★ The Apples in two colors give more versatile designs and allow for playing instructional activities.
- ★ A set of Weplay Apple Links can be used by a single child or by a group of children.

**Play Value:**

- ★ Fine movement ability can be strengthened through threading the Apples with the Needle Caterpillar and tying knots on the String.
- ★ Connecting the Apples, the Caterpillars, and the Leaves help to develop hand-eye-brain integration.
- ★ Children can enhance hand stability, muscle control and spatial concepts by stacking only the Apples or Caterpillars.
- ★ It promotes children's creative thinking through creative designs.
- ★ Spatial concepts are explored while children thread with the Needle Caterpillar and build concrete structures with different components.
- ★ Children can advance their attention and observation skills by moving the Needle Caterpillar backwards through the finished creation to release it.



ableplay RATING	
Weplay Apple Links serial #WEPL-AL23-0901-16	
DEVELOPMENTAL SKILL	RATING (1-5)
Communicative	★★★★★
Sensory	★★★★★
Social/Emotional	★★★★★
Cognitive	★★★★★
Physical	★★★★★

www.ableplay.org

Play products for children of all abilities  
Independent evaluation by National Lekotek Center

# KF0010 Weplay Cookie Festival



Age: 1 y 6 m+  
Components:  
Cookieman (lid + box) x 16 - 7.8 x 8 x 1.8 cm (L x W x H)

Lid				
Box	2	2	2	2
	2	2	2	2

Banana Base x 1 - 21 x 10.5 x 4.8 cm (L x W x H)



Interchangeable lids are ideal for sequencing and matching games.



**Fun with sounds**  
Stuffed Cookiemens make different sounds. Listen and take a guess! What is inside?

**Product Feature:**

- ★ Super-appealing Cookiemens in vibrant colors feature a myriad of assembling, piecing and stacking fun.
- ★ Banana Base can be used as a rocking bar (boat) for challenging stacking games. When turned upside down, it provides a groove for stacking games with a stable base.
- ★ The lids are interchangeable and can be opened or removed by children.
- ★ The ruffled side of the Cookiemens was designed to provide tactile stimulations. It also allowed Cookiemens to be stacked at more angles.
- ★ The Cookiemens are designed as boxes in which users can insert small objects such as beans or beads to produce different sounds. Modifying the weight of the Cookiemens brings additional challenges and fun to stacking games.



Banana bridge

Stacking game



Banana boat

able play RATING	
Weplay Cookie Festival	
series #WEPL-CF14-1101-15	
DEVELOPMENTAL SKILL	RATING (1-5)
Physical	★★★★★
Sensory	★★★★★
Cognitive	★★★★★
Social/Emotional	★★★★★
Communicative	★★★★★

www.ableplay.org

Play products for children of all abilities  
Independent evaluation by National Lekotek Center

**Play Value:**

- ★ Unlimited stacking fun enhances children's fine movement stability.
- ★ Playing Weplay Cookie Festival enriches children's creative thinking from 2D piecing to 3D stacking games.
- ★ Through the stacking process, children's concentration and frustration tolerance can be improved.
- ★ Interchangeable lids are ideal for playing color mix-and-match games to develop children's imaginations.
- ★ The unique Banana Base can be used as a rocking bar or a bridge to add extra challenge and provide different levels of stacking fun to increase children's symmetry and balance concepts.
- ★ Children can improve fine motor skills and enjoy the interactive play by mixing and matching the Cookiemens with various interchangeable color lids.
- ★ Children can advance their color cognition and sequence concept by playing the color identifying game.



# KF0008 Weplay Rock "N" Fish



Age: 3 y+  
Components:  
Fish x 2  
Starfish x 2  
Crab x 2  
Fish Hook x 3  
Single Rod x 2  
Rod Set x 1

INT'L PAT

3 y+



Children can play along with the sea animals. The 'push and swing' activity provides eye movement practice.



KF0008 + KP4005

The Rod Set for two children makes the fishing game more fun.



### Product Feature:

- ★ The Rod Set is designed for two users.
- ★ Lovely sea animals with special curve-based design create numerous fun and challenges.
- ★ Three different shapes of holes on the sea animals create different challenges.
- ★ The unique double Fish Hook design allows children to fish two sea animals at one time.
- ★ The Fish Hook fits the hands of younger children. Children can start from fishing with only the Fish Hook without the Fish Rod.

### Play Value:

- ★ Playing Weplay Rock "N" Fish enhances hand stability and muscle control.
- ★ Children can practice their hand-eye coordination, enhance their patience and improve observation skills while playing.
- ★ Through teamwork and competition, children can develop their social communication skills.
- ★ The push-and-swing design helps to build patience and problem-solving skills.
- ★ Children can improve their eye-tracking skills while observing the movement of the hook and the sea creature.



KF0008 + KT0016



able play RATING	
serial #WEBL-RF06-1001-13	
Weplay Rock "N" Fish	
DEVELOPMENTAL SKILL	RATING (1-5)
Physical	★★★★★
Sensory	★★★★★
Communicative	★★★★★
Cognitive	★★★★★
Social/Emotional	★★★★★
www.ableplay.org	
Play products for children of all abilities Independent evaluation by National Lekotek Center	

Promote teamwork and competition concept.

# KF0007 Weplay Jumbo Circus



Age: 1 y 6 m+  
Components:  
Elephant Block x 28

Color	Red	Yellow	Blue	Green
<b>S</b>	4	4	4	4
<b>M</b>	2	2	2	2
<b>L</b>	—	2	2	—

Plank x 4

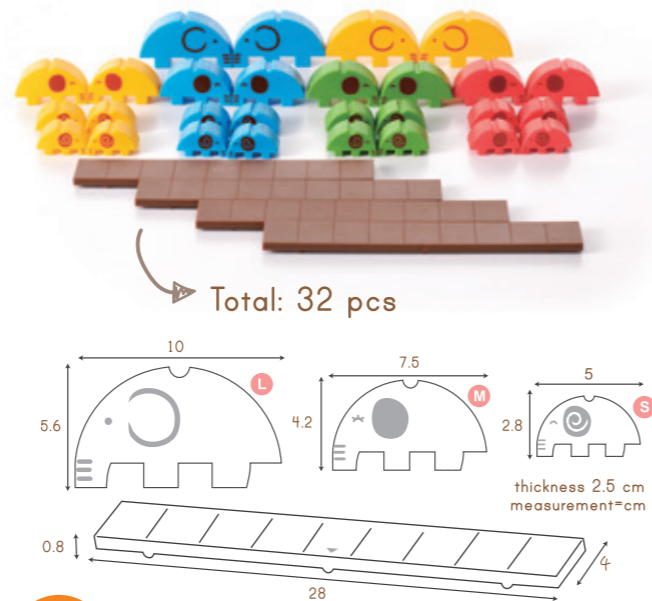

Children can practice two-hand coordination by separating the circular Elephant Blocks.

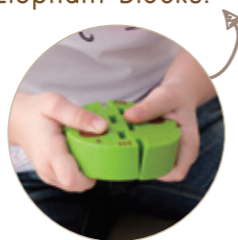

**Product Feature:**

- ★ Cute and colorful Elephant Blocks are created in 3 sizes and weights. Elephant Blocks are in 4:2:1 weight ratio for multiple learning and creative opportunities.
- ★ Two blocks of the same size can be combined into a circle for rolling games.
- ★ Stackable blocks provide unlimited possibilities for balance games and different levels of stacking activities.
- ★ Planks come with raised lines can be used as seesaws for balance concept activities.

## Stacking different sizes of blocks



**Play Value:**

- ★ Children can develop their fine motor skills by stacking and separating the blocks. This prepares the fine motor skills for handwriting.
- ★ Playing Weplay Jumbo Circus strengthens children's wrist muscles.
- ★ Children's attention can be improved by combining the same-sized blocks to form a circle and stacking them.
- ★ Through playing, children's basic arithmetic concept can be established.
- ★ Weplay Jumbo Circus promotes children's color cognition and size sequence concept.
- ★ It helps to develop teamwork skills by building complex structures.

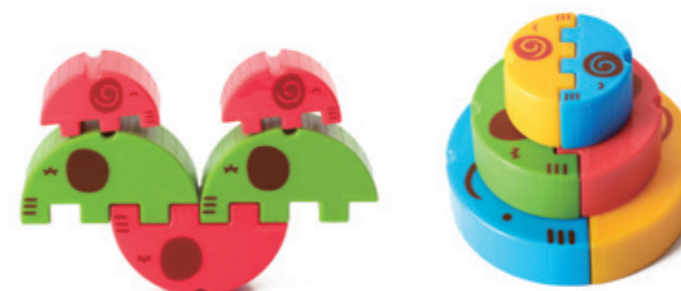

Three sizes of Elephant Blocks (4:2:1 weight ratio) with the Planks let children experiment with balance.



able play RATING	
Weplay Jumbo Circus serial #WEPL-JC12-1101-15	
DEVELOPMENTAL SKILL	RATING (1-5)
Physical	★★★★★
Sensory	★★★★★
Cognitive	★★★★★
Social/Emotional	★★★★★
Communicative	★★★

www.ableplay.org

Play products for children of all abilities  
Independent evaluation by National Lekotek Center

# KF0009 Weplay Rolling 4 Fun



Age: 3 y+  
Components:  
Four-sided Track x 1 - 28 x 25 x 4.5 cm (L x W x H)  
Ball x 2  
Replacement ball set: KF0002B

INT'L PAT

3 y+



2 balls for different challenging levels

**Product Feature:**

- ★ Weplay Rolling 4 Fun is designed with different tracks on all four sides.
- ★ It comes with two balls which are designed in different weights and surfaces, allowing to vary the rolling speeds and the levels of difficulty.
- ★ The differently patterned tracks offer a variety of activities.

Numbers on both sides help number recognition and ordinals.

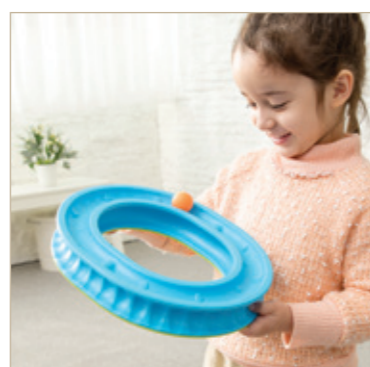

Spin, roll, tip and balance the ball along four different routes with Rolling 4 Fun

### A. Challenge Route

The track is designed with small obstacles to increase the fun and challenge.



### B. S-shaped Route

Roll the ball steadily along the consecutive S-shaped curve

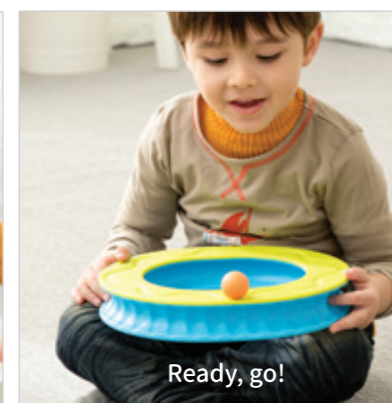

Ready, go!

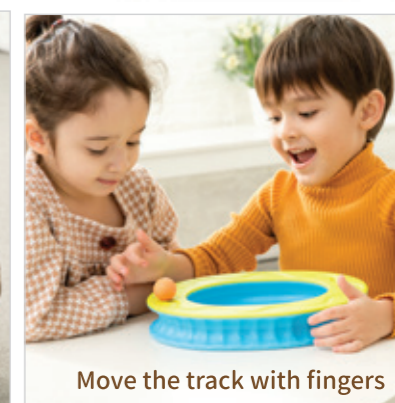

Move the track with fingers

### C. Stair Climbing

Move the ball along the stairs by flipping or blowing with the mouth



Blow the ball gently

### D. Speedy Spin

Spin the ball along the inner track without falling off



Roll the ball slowly



**able play RATING**  
serial #WEBL-RL07-1001-14

Weplay  
**Weplay Rolling 4 Fun**

DEVELOPMENTAL SKILL	RATING (1-5)
Communicative	★★★★★
Social/Emotional	★★★★★
Physical	★★★★★
Sensory	★★★★★
Cognitive	★★★★★

www.ableplay.org

Play products for children of all abilities  
Independent evaluation by National Lekotek Center

**Play Value:**

- ★ Keeping eyes on the moving ball enhances visual tracking ability and concentration.
- ★ Holding the track to do various activities improves the stability of the hands.
- ★ Blowing the small ball is good for the development of children's oral muscles.
- ★ Moving the ball forwards or backwards with the finger enhances the flexibility of the hand muscles.
- ★ The movement of arms and wrists can enhance the flexibility of upper limbs.

# KF0005, KF0006 Weplay Tricky Fish



Age: 3 y+  
Components: Board x 1, Ball x 1  
Dimensions: 25 x 21 x 3 cm (L x W x H)  
Replacement ball: KF0005A

INT'L PAT 3 y+



**Side A:**  
**The mini ball runs under the transparent cover.**  
Linear path (basic level) helps develop hand control. It is the foundation of daily self-care abilities, which is related to the stability of using utensils such as a spoon.

**Side B:**  
**Without a cover, users need to do their best to keep the big ball rolling along the track.**  
The circular path (advanced level) is similar to drawing circles. This is a good training tool for fine motor skills. It is related to the agility in writing, throwing and the movements of fingers.



ableplay RATING  
serial #WEPL-TF04-0701-12

Weplay  
Weplay® Tricky Fish

DEVELOPMENTAL SKILL	RATING (1-5)
Physical	★★★★
Sensory	★★★★
Cognitive	★★★★
Social/Emotional	★★★★
Communicative	★★★

www.ableplay.org  
Play products for children of all abilities  
Independent evaluation by National Lekotek Center

**Product Feature:**

- ★ The fish-shaped design brings a vivid image of a fish swimming in the hand.
- ★ It provides different challenging levels and is suitable for all ages from young children to seniors.
- ★ The ball can be placed in the hole as the fisheye for easy storage.

**Play Value:**

- ★ Playing Weplay Tricky Fish increases hand stability and finger dexterity.
- ★ Children can practice their hand-eye coordination through playing.
- ★ While playing with the Fish, children can enhance their visual tracking skills.
- ★ Children's concentration can be improved through the activities.



Tricky Fish trains children to hold cups or bowls steadily.

# KF0002.1 Infinite Loop (S)



Age: 3 y+  
Components:  
Track x 1 - 34 x 21 x 4,5 cm (L x W x H), Ball x 2  
Replacement ball set: KF0002B



ableplay RATING  
serial #WEPL-IL19-0511-16

Weplay  
Infinite Loop

DEVELOPMENTAL SKILL	RATING (1-5)
Physical	★★★★
Sensory	★★★★
Cognitive	★★★★
Communicative	★★★
Social/Emotional	★★★

www.ableplay.org  
Play products for children of all abilities  
Independent evaluation by National Lekotek Center

INT'L PAT

3 y+



**Product Feature:**

- ★ The innovative design allows the ball to roll continuously.
- ★ Smooth movement allows the ball to roll unimpededly.

**Play Value:**

- ★ Playing Infinite Loop improves children's hand-eye coordination.
- ★ It is great for physical agility, concentration and patience.
- ★ Infinite Loop comes with two balls of different weights and surfaces, allowing for varying speeds and levels of difficulty.
- ★ The easy movement helps to develop eye tracking ability.

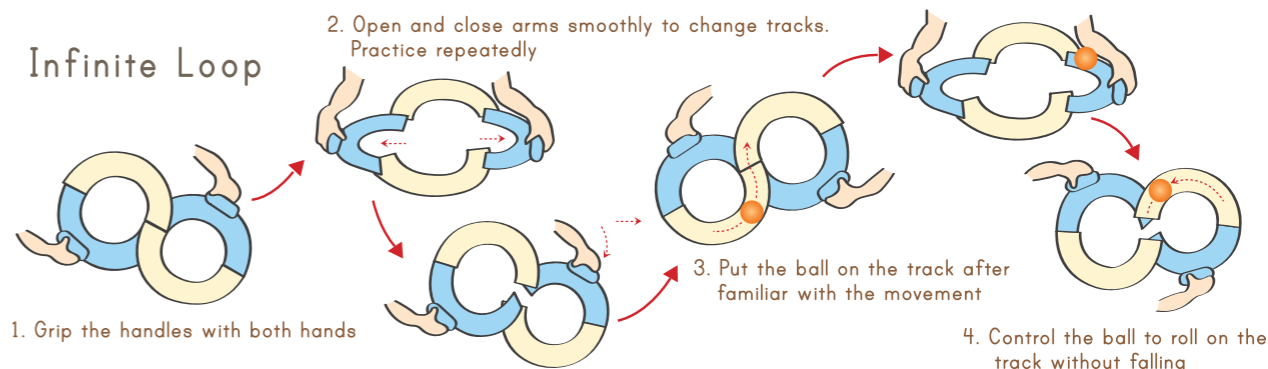

Weplay Infinite Loop is inspired by the philosophy of Oriental Tai Chi, which explores physical potentials through the essences of movement, symmetry and circulation. It is a small product with great fun!



2 balls for different challenging levels

# KF0004.1 Forever Up-Down (S)



Age: 3 y+  
Components:  
Track x 1 - 18 x 18 x 30 cm (L x W x H), Ball x 2  
Replacement ball set: KF0002B

INT'L PAT 3 y+



2 balls for different challenging levels



### Product Feature:

- ★ Forever Up-Down is designed as a sturdy construction with smooth sides for easy play.
- ★ It is created as an exterior maze.
- ★ The dynamic design is to coordinate the movements of the entire body.
- ★ The product can be turned inwardly or outwardly to keep the ball on the track.

### Play Value:

- ★ It comes with two balls of different weights and surfaces, allowing for varying speeds and levels of difficulty.
- ★ Playing Forever Up-Down trains hand-eye coordination and eye tracking.
- ★ Keeping the ball on the track practices maintaining concentration.

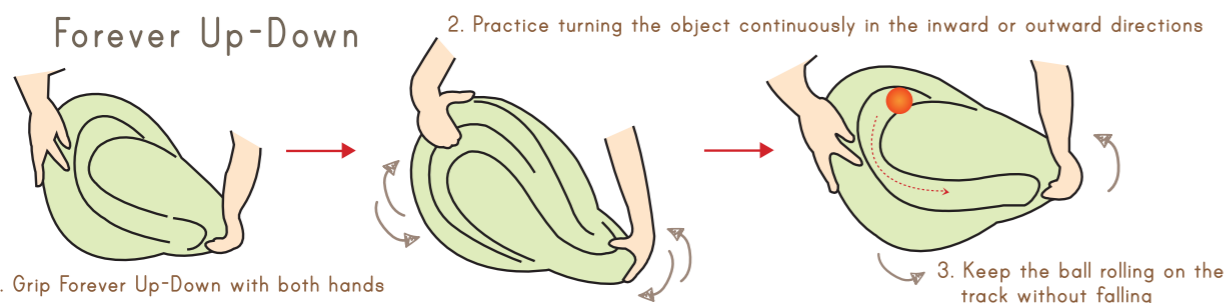

Developed from the concept of the Mobius strip as well as the Oriental philosophy of Tai Chi, this is a great product with fun for everyone.



## Creative Play Interaction

Developments in spatial concepts and creativity as well as peer interaction are crucial for children. Here at Weplay, we strive to create playful and educational toys that promote self-confidence in young children through construction, imagination, creative displays and teamwork.





# KC0006 Weplay Construction Tiles



Age: 3 y+  
 Components:  
 Rectangular Tile (L) x 8 - 24 x 12 x 0.4 cm (L x W x H)  
 Rectangular Tile (S) x 24 - 12 x 4 x 0.4 cm (L x W x H)  
 Square Tile x 24 (orange x 12, grey x 12) -  
 12 x 12 x 0.4 cm (L x W x H)  
 Triangle Tile x 8 - 20 x 7 x 0.4 cm (L x W x H)

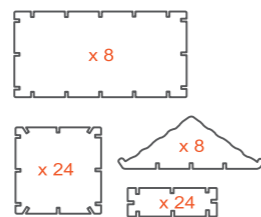

3 y+



### Product Feature:

- ★ Design concepts incorporate Oriental architecture. Weplay Construction Tiles provides a sense of beauty through wavy tiles, hollowed-out windows, and carved columns. The textured surface on the Tiles brings an enjoyable tactile quality.
- ★ Brick red, tangerine orange, and stone grey Construction Tiles can be made into delicate decorative objects. Adults and children enjoy the process of creating structures together.
- ★ Weplay Construction Tiles is easy to play with due to the large sizes and geometric shapes. From playing on the tabletop to creating the structures on the floor, Weplay Construction Tiles offers various ways for constructive play.
- ★ Triangle Tiles with upturned designs at the two ends can build a roof easily with the other Tiles. With four 45-degree notches, Square Tiles provides more different construction possibilities.
- ★ Playing with lights and natural elements adds more scenarios and makes the storytelling more creative.

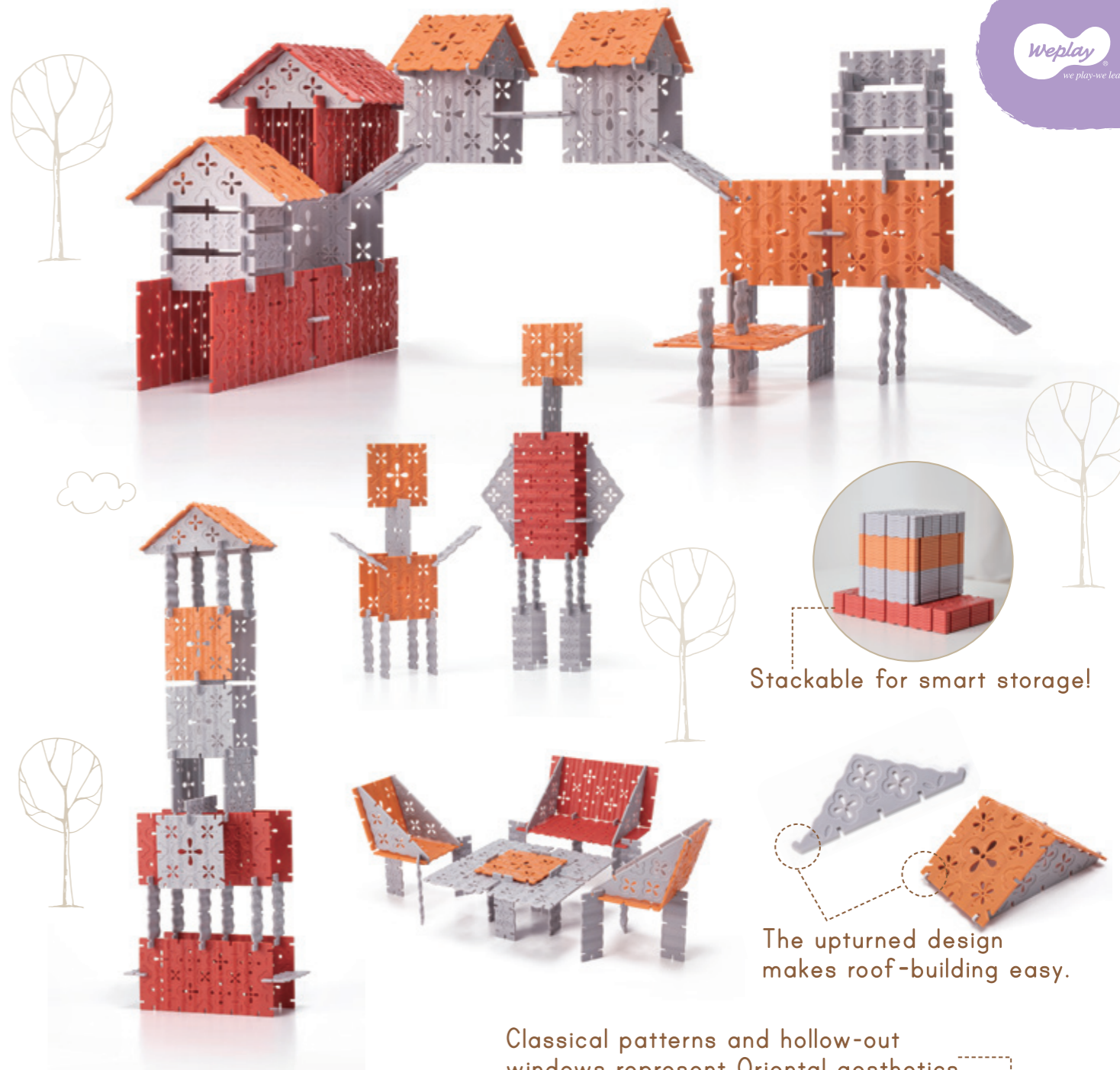

Stackable for smart storage!

The upturned design makes roof-building easy.

Classical patterns and hollow-out windows represent Oriental aesthetics.



### Play Value:

- ★ Creating different structures with Weplay Construction Tiles enhances 3D spatial recognition.
- ★ Building constructions and fitting different Tiles together challenges children's fine motor skills.
- ★ Incorporated with Oriental elements, Weplay Construction Tiles introduces the beauty of Oriental architecture.
- ★ Playing with Weplay Construction Tiles cultivates the aesthetic perception and creativity from building own constructions.

# KC2010 Weplay Crystal Spectrum Blocks



Age: 3 y+

Components:

Color	Red	Yellow	Blue	Transparent
Shape	8	8	8	8

INT'L PAT

3 y+



Double-sided Game Card x 6  
Dimensions: 7 x 7 x 4 cm (L x W x H)



Double-sided Game Cards



**Product Feature:**

- ★ This creative snowflake-shaped block is an open-ended play set that offers multiple ways of connection.
- ★ Children can start by fitting the notches to stack the Spectrum Blocks upright. When they are familiar with the Blocks, they can find more ways to connect and balance the blocks into different constructions. Adults can also join the game and brainstorm together.
- ★ Weplay Crystal Spectrum Blocks are in transparent and three vibrant primary colors. The transparent Spectrum Blocks add more color variance to the creative constructions.
- ★ Weplay Crystal Spectrum Blocks is perfect for playing with light. The Blocks are engaging under sunlight, flashlights or on a light panel. Lights add another level of play to this product.
- ★ The 6 double-sided game cards provide ideas such as buildings, transportation, and animals to inspire more creative works.

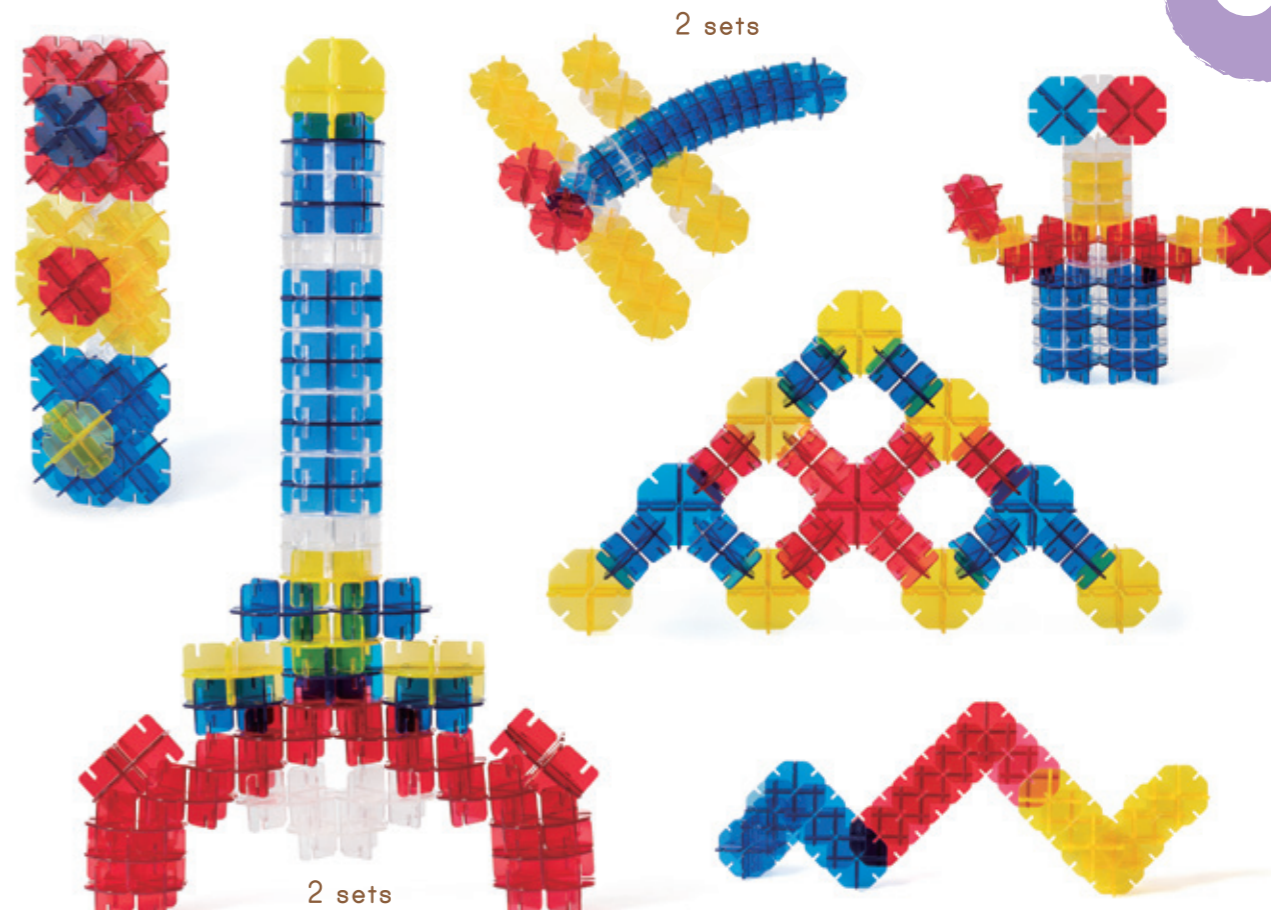

**Play Value:**

- ★ Weplay Crystal Spectrum Blocks include multiple surfaces and notches in different angles. The design enables children to learn spatial concepts.
- ★ The Spectrum Blocks can fit with each other from different angles, it challenges children's hand-eye coordination and fine motor skills.
- ★ While children are playing with the blocks, the colors mix and show different colors as the light passes through. Overlapping the transparent blocks with the color blocks creates different shades. The activities introduce children to color mixing and shades.
- ★ Weplay Crystal Spectrum Blocks cultivates children's creativity and artistic senses.
- ★ While fitting the blocks from different angles, children develop problem-solving skills and build confidence.



2 sets

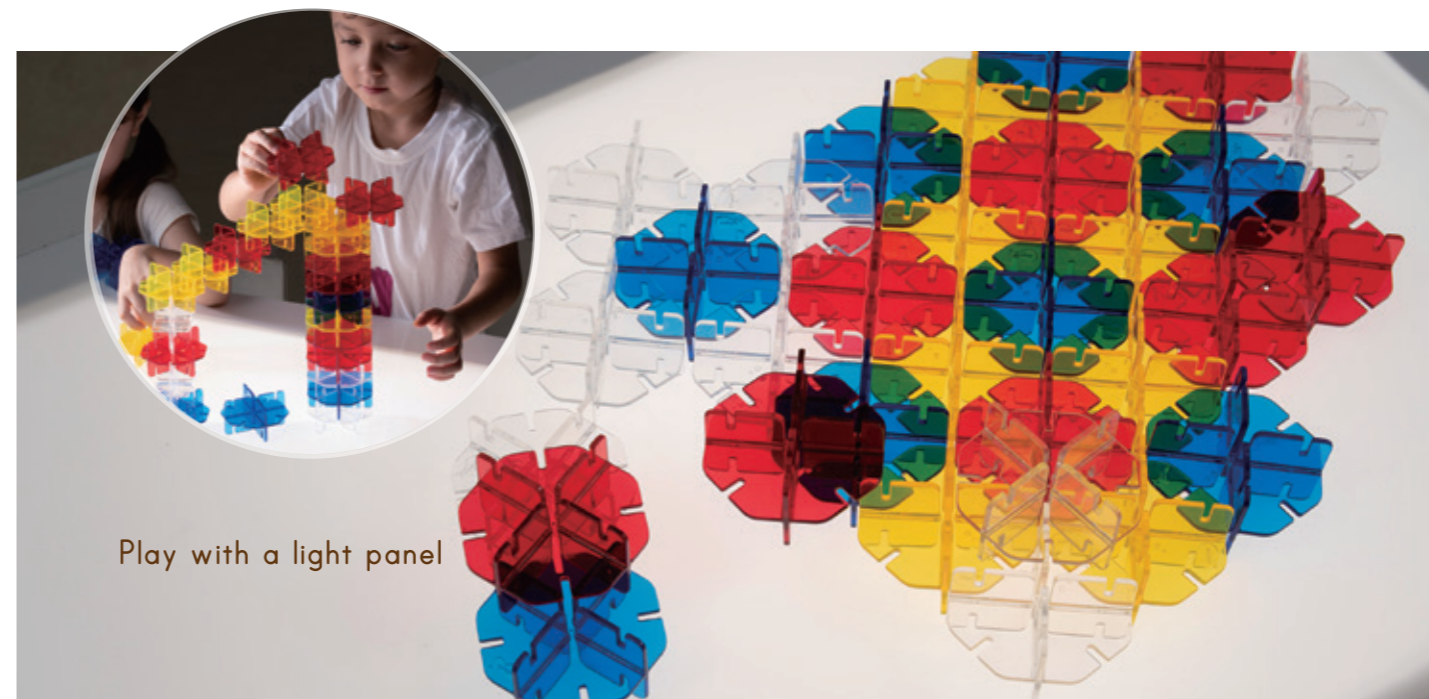

Play with a light panel

# KC0005 Icy Ice Building Set



Age: 2 y+  
 Components:  
 Icy Ice Block (L) x 28 (blue x 7, green x 7, orange x 7, white x 7)  
 Icy Ice Block (S) x 28 (blue x 7, green x 7, orange x 7, white x 7)  
 Dimensions:  
 Icy Ice Block (L): Ø 22.5 cm, thickness 1.5 cm  
 Icy Ice Block (S): Ø 10 cm, thickness 1.5 cm



Inter-locking design for easy and efficient storage



**Product Feature:**

- ★ These high-quality, hollow and large plastic blocks provide an open-ended platform for children to unleash their imaginations.
- ★ Small snowflake-shaped blocks with elaborate angle design offer infinite combinations.
- ★ Children can fit a small block into a large block to create more attractive colour combinations.
- ★ These beautiful multi-sized blocks can be easily connected together, allowing for endless possibilities of free creation.
- ★ Inter-locking design allows blocks to lock into place for easy and efficient storage.



**Play Value:**

- ★ Icy Ice Building Set helps to develop children's creativity, spatial concepts and visual thinking with unlimited construction possibilities.
- ★ Children's hand-eye coordination and fine motor skills are enhanced while they are building the blocks.
- ★ Building 2D and 3D constructions provides visual and spatial experiences.
- ★ Icy Ice Building Blocks allow children to build and explore through various combinations of imaginative play.

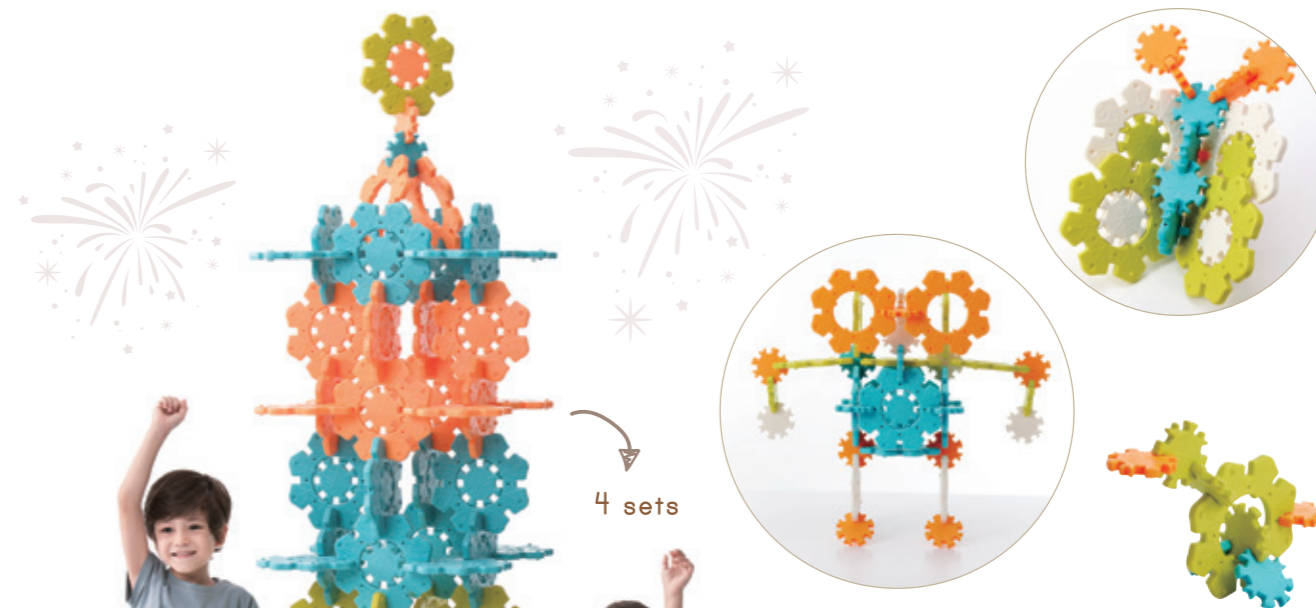

able play RATING	
serial #WEPL-II21-0511-16	
Weplay Icy Ice Building Set	
DEVELOPMENTAL SKILL	RATING (1-5)
Physical	★★★★★
Communicative	★★★★★
Cognitive	★★★★★
Social/Emotional	★★★★★
Sensory	★★★★
www.ableplay.org	
Play products for children of all abilities Independent evaluation by National Lekotek Center	

# KC0004, KC0004-032, KC0004-065 Weplay Q-Blocks



Age: 1 y 6 m+  
Colors: red, yellow, blue, green  
Shapes: rectangle, square, curve

1y6m+ STEAM Jr.



Special "Soft" Material,  
Play Quietly



KC0004 4 colors each shape



KC0004-065  
(KC0004 + carrying bag)



KC0004-032  
4 colors each shape

Light & safe



Measurement=cm

Shape				Total
KC0004	16	16	32	64
KC0004-032	8	8	16	32
KC0004-065	16	16	32	64+1 bag



KC0004 x 2 sets



KC0004 x 3 sets

**Product Feature:**

- ★ High-quality material brings safety and fun to young children.
- ★ Safe and light-weight material reduces noises when the block is dropped on the floor.
- ★ Simple geometric shaped bricks can create unlimited constructions and designs.
- ★ It is easy to grasp and build with. Squatting, standing and stretching are often required when building large structures, which helps young children develop their physical movement.

**Play Value:**

- ★ Playing Weplay Q-Blocks helps to develop imagination and creativity.
- ★ Children's hand-eye coordination and motor development can be promoted through the activities.
- ★ Visual experiences and spatial concepts are provided while children build the constructions.
- ★ Children can learn teamwork and improve their social skills while playing with peers.



Made of soft material



KC0004 x 3 sets



KC0004 x 3 sets



# KC3001 Weplay Learning Cube



Age: 10 m+  
Components:  
Panel x 6 - 21 x 21 cm (L x W), Block x 12  
Each shape comes in three heights: 2 cm, 4 cm, 6 cm

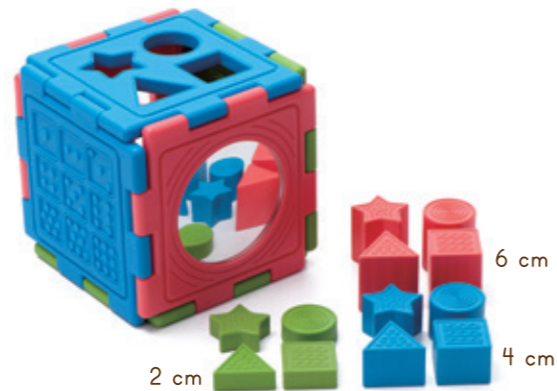
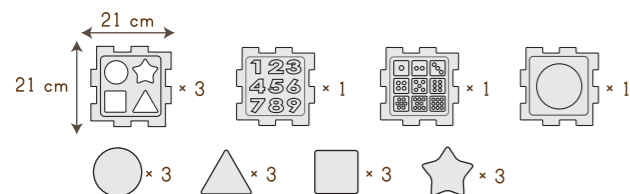

An all-in-one creative cube set!

10 m+ STEAM Jr.

Stimulate tactile perception

Match the shapes with the same patterns



**Product Feature:**

- ★ 6 panels can be connected to a larger play platform or assembled into a cube for 2D and 3D games.
- ★ Weplay Learning Cube is designed in 4 shapes of blocks (circle, triangle, square and star) for basic shape recognition.
- ★ The blocks are in 3 colors and 3 heights to develop the concepts of height and sequence.
- ★ The mirror panel stimulates visual exploration.
- ★ The numbered and dotted panels introduce numeral concepts.



Extended product:  
Weplay Stepping Shape  
KC3004 P.135

KC3001 + KC3004



**Play Value:**

- ★ Weplay Learning Cube helps to develop shape and color recognition, the concept of sequence, height, and basic math.
- ★ Children's hand-eye coordination and hand muscle control can be improved while playing with Weplay Stepping Shape.
- ★ The shape and spatial concepts can be built by playing height and shape matching games.
- ★ The different patterns on the shapes provide tactile experiences.
- ★ Children can practice writing by tracing the shapes and numbers on the panel.

Children can look and touch the tactile patterns on the blocks and find the shaped blocks with the same patterns.

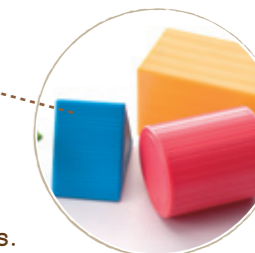

Match the shapes - 2D

Learn to write

Play with the mirror

# KC3002, KC3002-028 Weplay We-Blocks Mini



Age: 2 y+

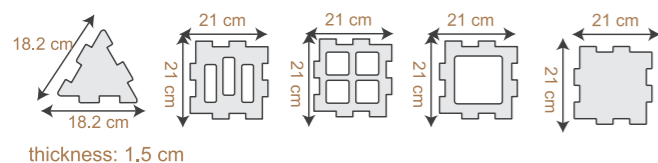

Shape							Total
KC3002	4	4	8	8	12	20	56
KC3002-028	2	2	4	4	6	10	28



Stackable for easy storage

Various colorful panels now turn into magical 3D creations!

2 y+ STEAM Jr.



**Product Feature:**

- ★ 5 different shapes of panels are designed for different construction options.
- ★ Each set includes various structural frames such as windows and squares.
- ★ Different textures on the panels provide tactile stimulation.
- ★ The stackable design made the panels easy to store.



**Play Value:**

- ★ Playing Weplay We-Blocks Mini helps to develop visual and spatial concepts.
- ★ Children can learn to convert the 2D blocks into 3D models.
- ★ Fine motor skills can be strengthened through playing with We-Blocks Mini.
- ★ Children build their confidence through construction, imagination and creative display. They also show their talents and build teamwork spirit while playing.



# KC2008 Weplay Beanstalk



Age: 3 y+

Components:

Bean	6 colors×30=180
Board	2
Mirror	2
Stick	4

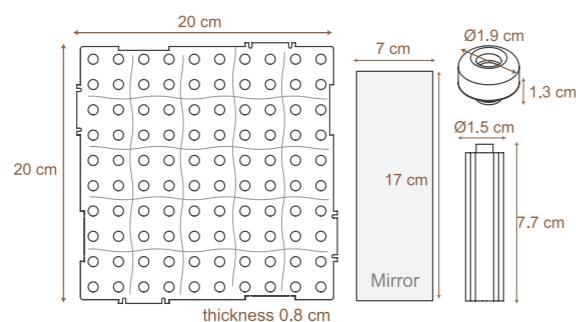

The boards can be connected to each other.

3 y+



Children can use the stick to pull out the Beans. This helps to develop children's hand-eye coordination.

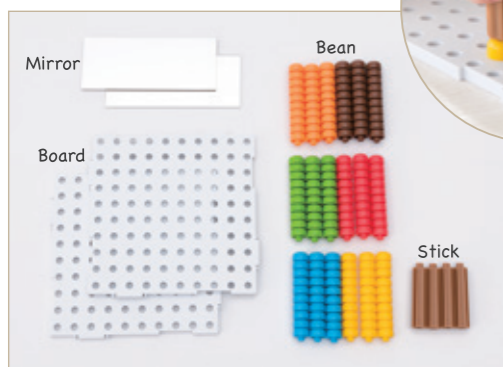

## Hanging as a wall play item

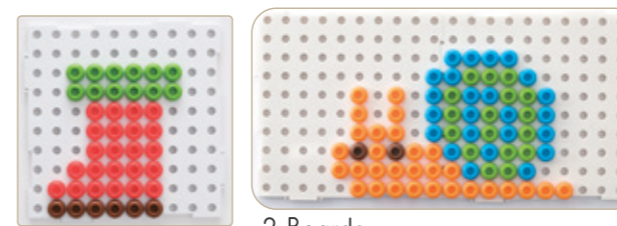

2 Boards

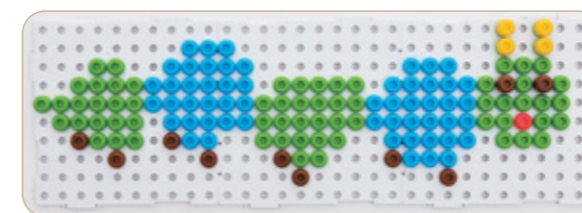

3 Boards

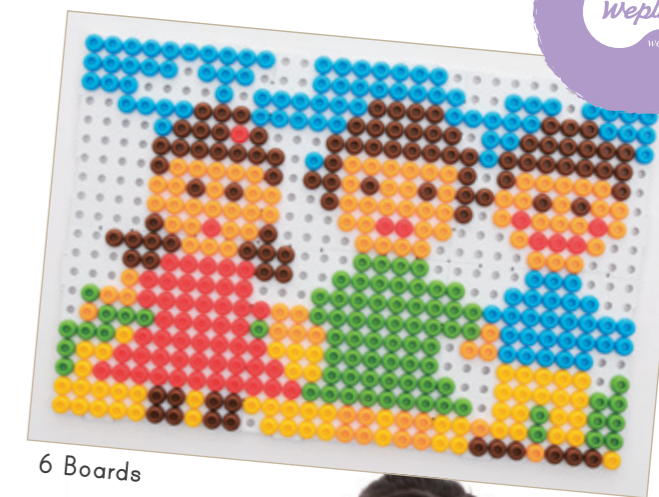

6 Boards

### Product Feature:

- ★ The Beans can be stacked together to extend creations from 2D to 3D.
- ★ The Boards can be connected to each other for a larger playing platform.
- ★ The multi-functional Sticks can be used to either support the mirrors or pull out the Beans from the boards.
- ★ The Mirrors allow children to experiment with symmetry.

### Play Value:

- ★ Playing Weplay Beanstalk helps to develop color and pattern recognition.
- ★ Hand-eye coordination can be improved through playing with Beanstalk.
- ★ Children can develop spatial, visual and symmetry concepts through the activities with Beanstalk.



### 2D designs

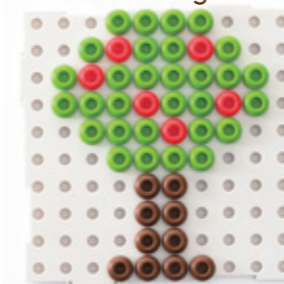

### Stackable beans



2 Boards

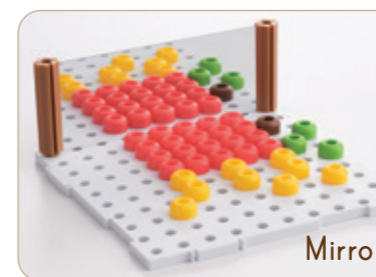

Mirrors & Beans

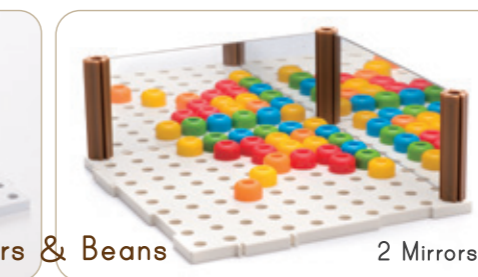

2 Mirrors

### Extended Product: Weplay Puzzle Fun KC2009 P.134

KC2008 + KC2009

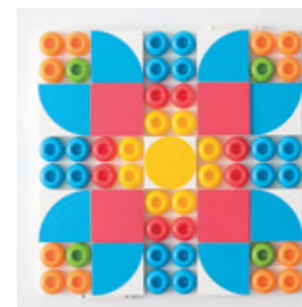
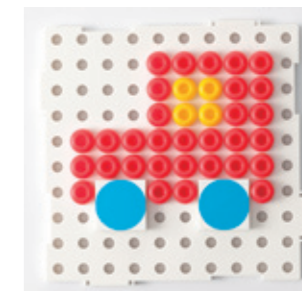

KC2008 + KC2009  
12 Boards

Use the mirror with the Beanstalk for symmetry concepts

# KC2009 Weplay Puzzle Fun



Age: 2 y+

2 y+

STEAM Jr.

### Components:

Color Shape	Red	Orange	Yellow	Green	Blue	Brown	Total
	5	5	4	5	4	4	27
	2	2	2	2	2	2	12
	4	4	4	4	4	4	24
	2	2	2	2	2	2	12
Board	2 pcs						75

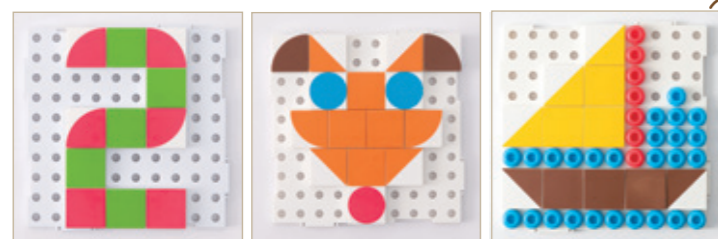
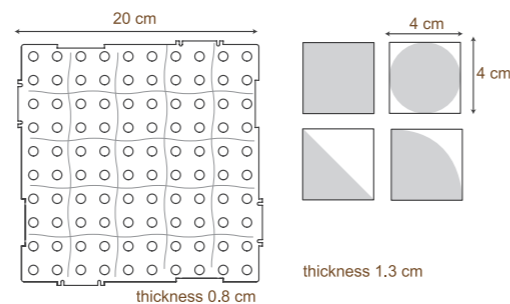

KC2008 + KC2009

Extended product: Weplay Beanstalk  
KC2008 P.132

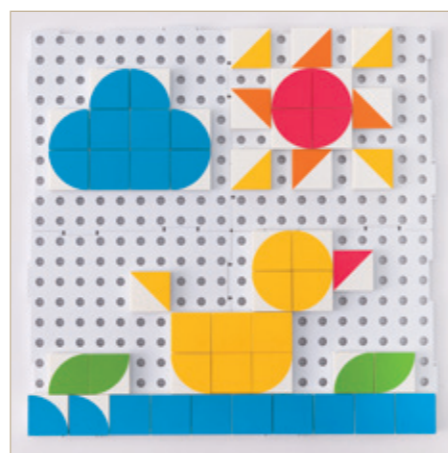

4 Boards

### Product Feature:

- ★ Multiple graphics and colors are designed on the tiles.
- ★ The tiles are designed in a size which children can place and remove easily.
- ★ The Boards can be connected to each other for a larger playing platform.

### Play Value:

- ★ Structural concepts can be built while children play Weplay Puzzle Fun.
- ★ Spatial and visual concepts are enhanced while children are piecing their own artworks.
- ★ Fine motor skills can be developed during the creative play activities.



A perfect size for children to grip

The boards can be connected to each other.

# KC3004 Weplay Stepping Shape



Age: 10 m+

Block x 16

Each shape comes in four heights:

2 cm, 4 cm, 6 cm, 8 cm

Base x 1 - 30 x 30 cm (L x W)

x4 x4 x4 x4

10 m+

STEAM Jr.



### Tactile recognition



KC3001 + KC3004



Extended product:  
Weplay Learning Cube  
KC3001 P.128

### Product Feature:

- ★ The blocks are designed with cylindrical, triangular, cubic and star-shaped prisms at four different heights.
- ★ The grey base acts as a game platform and for neat storage.
- ★ The textured blocks with different patterns provide sensory stimulation to children.

### Play Value:

- ★ Blocks in different colors, shapes and heights develop sequencing concepts.
- ★ Children learn basic geometric and mathematical concepts through playing this colorful and fun game.
- ★ The tactile perception helps to stabilize emotions.
- ★ Playing Weplay Stepping Shape improves children's hand-eye coordination and hand muscle control.

### Basic multiplication concept

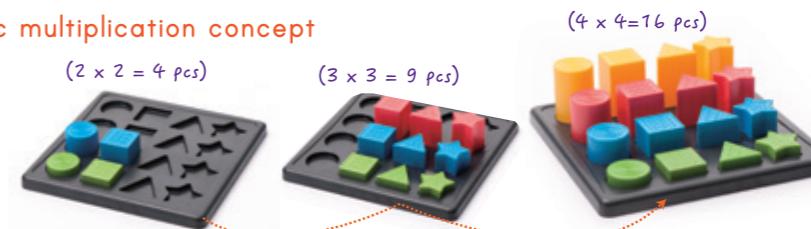

Sequence (2-8 cm)

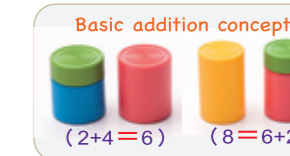

Basic addition concept

# Stack n' Stack KC0003

Age: 4 y+

Components:

Panel x 68

Opener x 4

STEAM Jr.

Stackable for space saving!

INT'L PAT

4 y+



Disassemble by opener



Openers



### Product Feature:

- ★ Stack n' Stack is a colorful and large-scale building blocks.
- ★ The Panels are assembled to create the building blocks. Each panel is stackable for cost-efficient shipping and minimal storage.
- ★ Four openers are included for disassembling.

### Play Value:

- ★ The product offers 3D activities and fun building experiences.
- ★ The spatial concepts and artistic creativity are developed through constructing the blocks.
- ★ Children can explore their physical potential, especially fine motor skills when assembling the blocks.
- ★ Children's active planning abilities and social skills are enhanced through teamwork.

### Attention:

This product is only intended to be a children's stacking toy. Do not sit or stand on the assembled product.

Shape				Total
Item	Square 20 x 20 cm (L x W)	Rectangle (L) 20 x 40 cm (L x W)	Rectangle (S) 20 x 28.3 cm (L x W) (for building triangle blocks)	
KC0003 Stack n' Stack	x 11 x 11 x 11 x 11 (44 pcs)	x 5 x 5 x 5 x 5 (20 pcs)	x 1 x 1 x 1 x 1 (4 pcs)	68



# Weplay Art Block

### Design Concept:

Bringing natural elements into table play, the Weplay Art Block Series of blocks introduces colors of the rainbow, sunflowers, oceans, lavender and the forest. Instruction cards are included in each set for activities from entry to challenging levels to enrich user's creativity.

This series includes five different sets. Each set integrates visual art, creative construction, fine motor skills development, mathematical and logical concepts. Creative and interactive play helps children to develop physical and cognitive potential in a uniquely fun way.

### Development Concept :

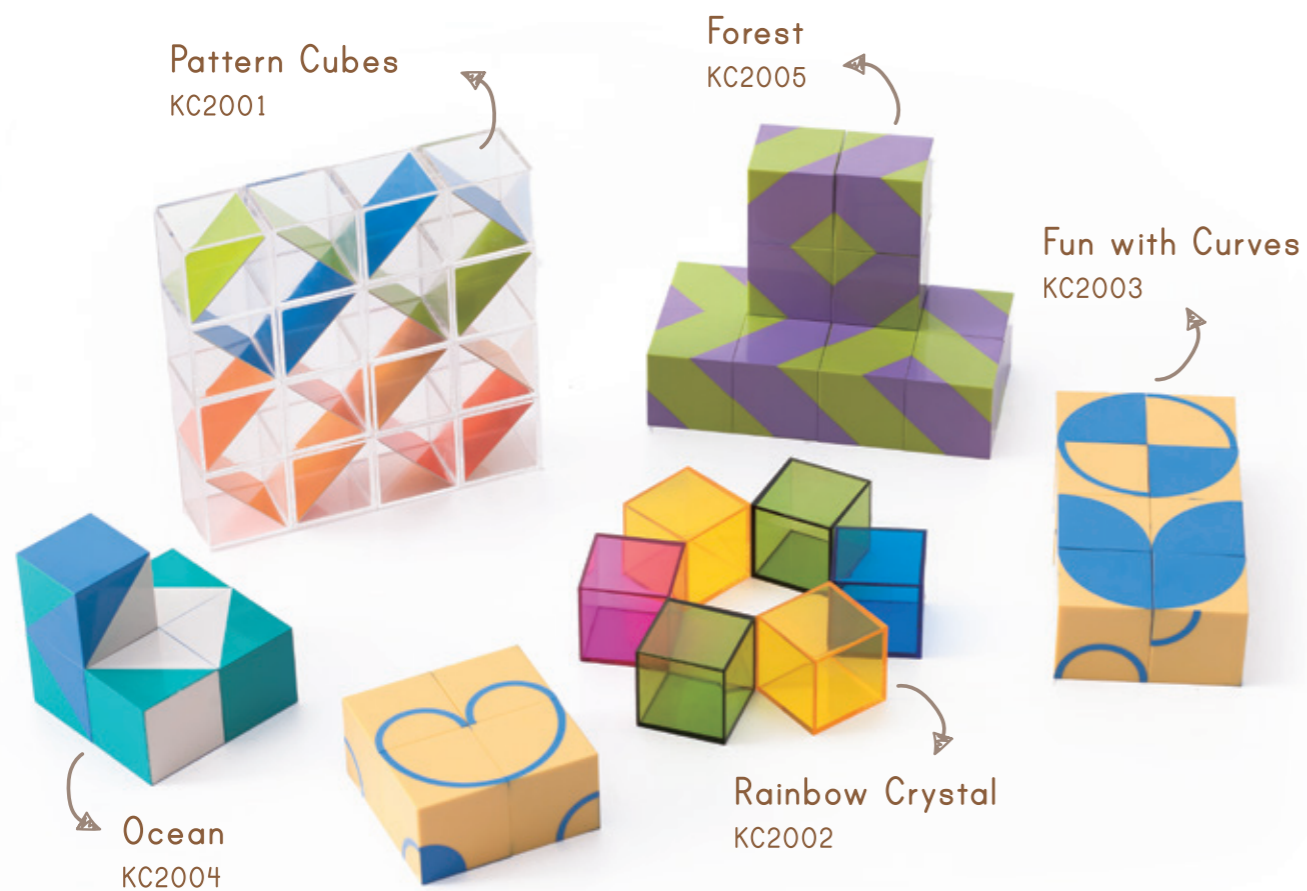
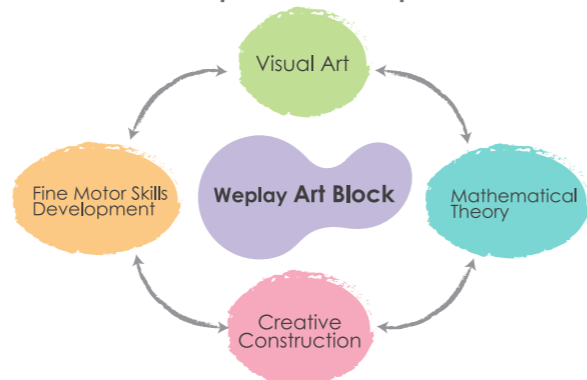

Pattern Cubes  
KC2001

Forest  
KC2005

Fun with Curves  
KC2003

Rainbow Crystal  
KC2002

Ocean  
KC2004



Extended Product:  
Sound Block KT5001 P.58



# KC2001 Pattern Cubes



Age: 3 y+

Components:

Block x 16 (green / blue x 8, yellow / orange x 8)

Double-sided Game Card x 6

Dimensions: 5 x 5 x 5 cm (L x W x H)

INT'L PAT

3 y+



### Product Feature:

★ With the transparent visual effect of a glass pyramid, a dual-color card (cold vs. warm tone) is placed diagonally inside the block, which creates unique visual perspectives.

### Play Value:

★ The transparent blocks allow children to familiarize themselves with the mathematical concepts of symmetry, sequence, parallels, comparison and actual vs. virtual space.



able play RATING	
Weplay Weplay Art Blocks	
serial #WEPL-AB02-0625-08	
DEVELOPMENTAL SKILL	RATING (1-5)
Sensory	★★★★★
Communicative	★★★★★
Cognitive	★★★★★
Social/Emotional	★★★★★
Physical	★★★

www.ableplay.org  
Play products for children of all abilities  
Independent evaluation by National Lekotek Center



# KC2002 Rainbow Crystal

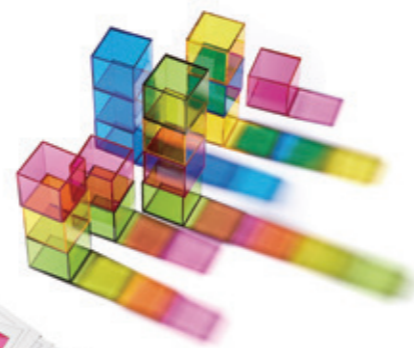

Age: 3 y+  
Components:  
Translucent Block x 16 (red x 4, yellow x 4, blue x 4, green x 4)  
Double-sided Game Card x 6  
Dimensions: 5 x 5 x 5 cm (L x W x H)

3 y+



able play RATING	
serial #WEBL-AB02-0625-08	
Weplay Weplay Art Blocks	
DEVELOPMENTAL SKILL	RATING (1-5)
Sensory	★★★★★
Communicative	★★★★★
Cognitive	★★★★★
Social/Emotional	★★★★★
Physical	★★★★

www.ableplay.org  
Play products for children of all abilities  
Independent evaluation by National Lekotek Center

**Product Feature:**

★ Inspired by the colors of the rainbow, this set of vividly colored blocks develops young children's color recognition skills.

**Play Value:**

- ★ This Rainbow Crystal with vividly colored blocks allows children to construct beautiful and creative shapes and images.
- ★ While playing with the blocks, children experience spatial art through sequences, colors and images.
- ★ Children can view the blocks under light and observe how two different colors blend with each other.



# KC2003 Fun with Curves



Age: 3 y+  
Components:  
Block x 16  
Double-sided Game Card x 6  
Dimensions: 5 x 5 x 5 cm (L x W x H)

3 y+



able play RATING	
serial #WEBL-AB02-0625-08	
Weplay Weplay Art Blocks	
DEVELOPMENTAL SKILL	RATING (1-5)
Sensory	★★★★★
Communicative	★★★★★
Cognitive	★★★★★
Social/Emotional	★★★★★
Physical	★★★★

www.ableplay.org  
Play products for children of all abilities  
Independent evaluation by National Lekotek Center

**Product Feature:**

- ★ Each side has a pattern of solid or hollow quarter/half circles in blue and yellow. The color combination is like sunflowers under the sky.
- ★ Simple elements of lines and areas inspire children's creativity.

**Play Value:**

- ★ Learning fractions can be so much fun! Children can enjoy learning the mathematical concepts and creating plentiful interesting images from 2D to 3D with these blocks.



# KC2004 Ocean



Age: 3 y+  
Components:  
Block x 16  
Double-sided Game Card x 6  
Dimensions: 5 x 5 x 5 cm (L x W x H)



### Product Feature:

★ Inspired by scenes of the ever-changing ocean, this block set incorporates colors of the sky, ocean and clouds into simple geometric patterns of triangles and squares. The possibilities of arrangement are unlimited.

### Play Value:

- ★ The blocks help to learn mathematical concepts, image creations, 2D and 3D constructions.
- ★ The similarity of blue colors is good for improving children's color recognition.
- ★ Ocean Blocks make it easy and fun to explore geometric concepts.

able play RATING  
Weplay Weplay Art Blocks  
serial #WEBL-AB02-0625-08

DEVELOPMENTAL SKILL	RATING (1-5)
Sensory	★★★★★
Communicative	★★★★★
Cognitive	★★★★★
Social/Emotional	★★★★★
Physical	★★★★★

www.ableplay.org  
Play products for children of all abilities  
Independent evaluation by National Lekotek Center



# KC2005 Forest



Age: 3 y+  
Components:  
Block x 16  
Double-sided Game Card x 6  
Dimensions: 5 x 5 x 5 cm (L x W x H)



### Product Feature:

★ Inspired by the color of green sprouts and lavender, this design intends to bring the beauty of nature into play.

### Play Value:

- ★ Geometry can be so much fun! The games include image recognition, image creation, stacking, as well as 2D and 3D construction.
- ★ The dual color combination along with the lines and planes on the blocks gives children different visual effects.

able play RATING  
Weplay Weplay Art Blocks  
serial #WEBL-AB02-0625-08

DEVELOPMENTAL SKILL	RATING (1-5)
Sensory	★★★★★
Communicative	★★★★★
Cognitive	★★★★★
Social/Emotional	★★★★★
Physical	★★★★★

www.ableplay.org  
Play products for children of all abilities  
Independent evaluation by National Lekotek Center



# KC0001.1 Octagon Creative Blocks

Age: 6 m+  
Components:  
Block x 12  
(red x 3, yellow x 3, blue x 3, green x 3)  
Dimensions: 38 x 19 x 11.5 cm (L x W x H)  
Maximum load: 50 kg

INT'L PAT

6 m+

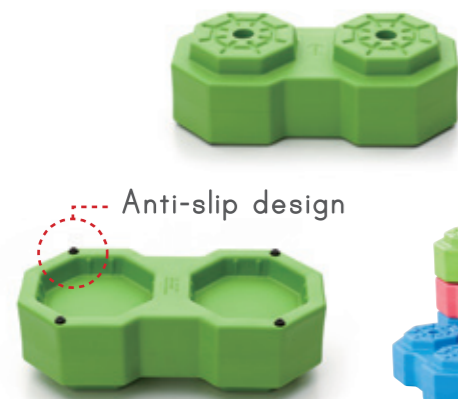

Anti-slip design



Ball pool  
4 sets

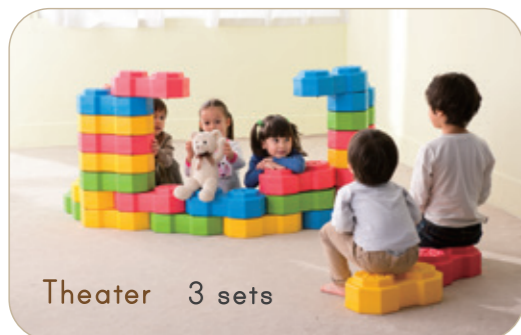

Theater 3 sets

**Product Feature:**

★The unique Octagon Creative Blocks are ideal for a school setting and can be used as decoration or seats for toddlers.

**Play Value:**

★The building blocks can be used to make a ball pool, sandbox or a maze. Learning is so much fun and colorful!



Cube maze

2 sets

# KC0002.1 Brick Me

Age: 2 y+  
Components:  
Large x 30 (red, yellow, blue, green, orange)  
Small x 15 (red, yellow, blue, green, orange)

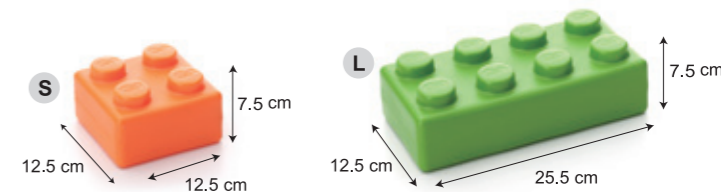

2 y+

STEAM  
Jr.



**Product Feature:**

★Brick Me is a large-scale, lightweight and interlocking building block set. Building endless colorful creations can be so easy for young children.

**Play Value:**

★Children's imagination, hand-eye coordination and motor skills are developed while children have creative playtime.  
★Brick Me is ideal for teamwork or individual play.



# Softwood Blocks

KC2801 (8 cm thick / 56 pcs)  
 KC2802 (4 cm thick / 152 pcs)  
 KC2802-068 (4 cm thick / 68 pcs)

Age: 0 y+  
 KC2801: total 56 pcs  
 KC2802: total 152 pcs  
 KC2802-068: total 68 pcs  
 Material: High-grade EVA foam

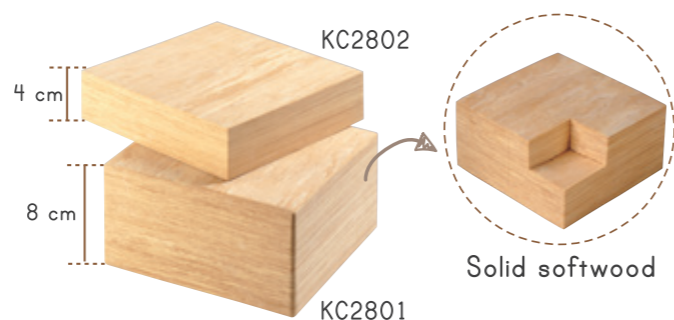

Solid softwood

**Product Feature:**

★ These lightweight, soft and durable building blocks are made of high-grade EVA material with unique wood grain patterns to mimic real wood. Children can enhance their capability of structural understanding and imagination while playing.

**Special "Soft" Material, Play Quietly**



KC2802  
(4 cm thick)



KC2802-068  
(4 cm thick)

**Play Value:**

- ★ Playing the Blocks helps to stimulate children's creativity and imagination.
- ★ Children's motor coordination is enhanced through playing.
- ★ Shape recognition is promoted while children play with the Softwood Blocks.
- ★ It is helpful to cultivate children's spatial concepts.
- ★ By playing the blocks, children's gross motor skills and fine motor skills are improved.
- ★ Children practice their hand stability when stacking the blocks.
- ★ Playing with others encourages teamwork and peer interaction.



KC2801  
(8 cm thick)

Shape																		Total
<b>KC2801</b> (8 cm thickness)	8	8	8	8							4	4	4	2	2	8		56
<b>KC2802</b> (4 cm thickness)	16	8	16	8	16	8	8	16	16	16	4	4	4	4	4		4	152
<b>KC2802-068</b> (4 cm thickness)	4	4	4	4	8	8	8	8	8	12								68

# KC2803 Linkits



Special "Soft" Material,  
Play Quietly

Age: 6 m+  
Components: Brick x 95 (red, yellow, blue, green, orange)  
Material: High-grade EVA foam



The bricks come in three shapes: full brick with two hollow circles, half brick with a hollow circle, and solid column brick which can be fitted into either of the bricks. Linkits can enhance children's creativity and infinite imagination.

Children enhance grip strength and muscle stability in their hands by creating 2D and 3D models with Linkits. It also helps to develop teamwork and peer interactions as children work together to build shapes and designs from their imaginations!

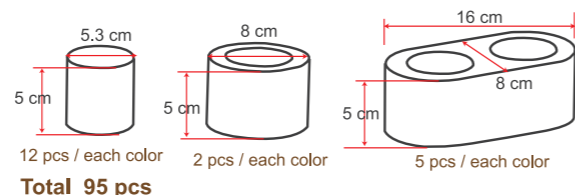

ableplay RATING	
serial #WEBL-LK06-0801-09	
Weplay Linkits	
DEVELOPMENTAL SKILL	RATING (1-5)
Sensory	★★★★★
Communicative	★★★★★
Cognitive	★★★★★
Social/Emotional	★★★★★
Physical	★★★★★
www.ableplay.org	
Play products for children of all abilities Independent evaluation by National Lekotek Center	



Pulling the column brick out of the full/half brick helps to develop children's grip strength.



# KC1801-00M (Color) 3D Creative Mat



Special "Soft" Material,  
Play Quietly

Age: 0 y+  
Dimensions: 50 x 50 x 1.5 cm (L x W x H)  
Material: High-grade EVA foam

Different colors and patterns on each side to create various ways to play.

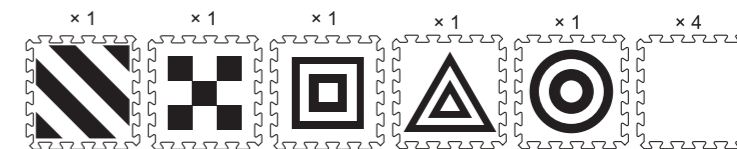

Total : 9 pcs / set

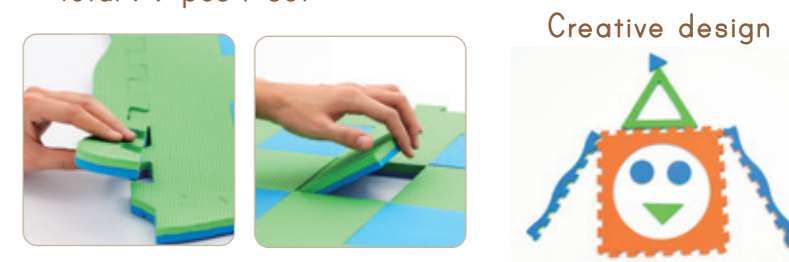

Play Value:

- ★ The activities with 3D Creative Mat help to develop children's motor skills and build 2D and 3D creative concepts.
- ★ Creative Mat provides children with visual stimulation.
- ★ Children can crawl, walk and explore the space created with 3D Creative Mat.

More than a mat!



Different colors and patterns on each side create various ways to play.



Light, safe and neat



# KC2805 Nest & Stack



Special "Soft" Material,  
Play Quietly

Age: 0 y+  
Components:  
Frame x 5 (red x 1, yellow x 1, blue x 1, green x 1, orange x 1)  
Dimensions:  
Red: 30 x 30 x 30 cm (L x W x H)  
Yellow: 25 x 25 x 25 cm (L x W x H)  
Blue: 20 x 20 x 20 cm (L x W x H)  
Green: 15 x 15 x 15 cm (L x W x H)  
Orange: 10 x 10 x 10 cm (L x W x H)  
Material: High-grade EVA foam

0 y+

Low  
Formamide

**Product Feature:**

- ★The whole set can be easily packed into one unit for easy storage.
- ★Nest & Stack can be stacked, laid and used to create large structures.

**Play Value:**

- ★Children's motor skills are developed through various activities.
- ★It helps to learn the concepts of color, size and sequence through playing.
- ★Nest & Stack can also be the containers for sorting games.



# Balls & Fittings

Balls are synonymous with playtime. They not only provide hours of fun, but also enhance children's reactions and coordination. Weplay also offers educational fittings for all your children's needs.



# KE0011-00B, KE0011-00S Weplay Rocking Volcano



Age: 3 y+  
Dimensions:  
Bottom Ø 35.7 cm x 30 cm (H),  
Top Ø 26.2 cm  
Maximum load: 60 kg

3 y+

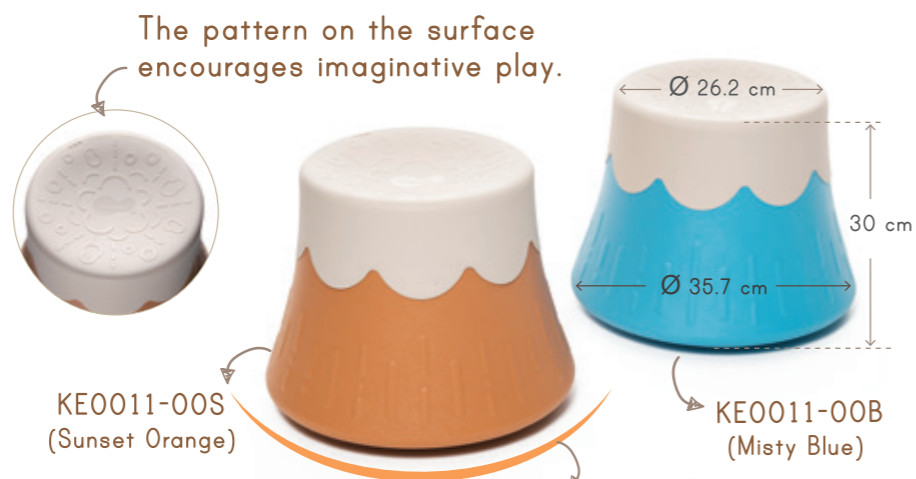

KE0011-00S  
(Sunset Orange)

KE0011-00B  
(Misty Blue)

The arc-shaped bottom allows for movements in all directions.

**Product Feature:**

- ★ Rocking Volcano is designed with the look of a volcano. It has an arc-shaped bottom, which allows for movements in all directions.
- ★ Rocking Volcano transforms conventional sitting into a fun activity by providing an outlet for children to move around while remaining seated.
- ★ Swinging and rotating the Rocking Volcano while maintaining body balance helps children regulate emotions and build muscles.
- ★ A comfortable and concave seat naturally guides children to a proper sitting position. The pattern on the surface encourages imaginative play.
- ★ It is also suitable for adults! The movements help users loosen tight muscles from excessive sitting.



**Play Value:**

- ★ Continuously moving and sitting promote core strength and improve concentration.
- ★ Spinning around while sitting on the Rocking Volcano encourages vestibular input and develops better balance.



Children engage their core muscles to maintain stability while sitting in proper posture. This offers an active sitting practice!



KE0006 - 26 cm  , KE0005 - 30 cm  ,  
KE0004 - 34 cm 

## Weplay Chair

Age: 1 y+

Maximum load: 80 kg

INT'L PAT

1 y+



26 cm

30 cm

34 cm



The chair back is slightly flexible, allowing children to sit comfortably!

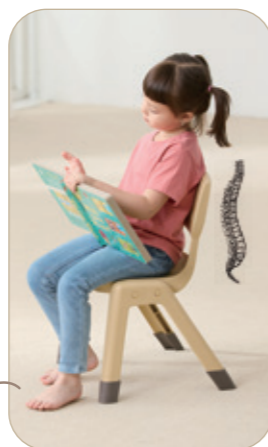

Stackable for easy storage



7cm

- ★Ergonomic design helps to correct children's posture and maintain a healthy spine.
- ★Weplay Chair is stackable for easy storage.
- ★The flexible chair back design ensures long-lasting comfort.
- ★The hollow at the lower back allows ventilation and makes it easy to carry.
- ★Anti-slip foot cover on each foot avoids scratches on the floor.
- ★It is suitable for both adults and children.



New Color

Anti-slip foot cover on each foot avoids scratches on the floor.

## KE0014, KE0015 Cot

0 y+

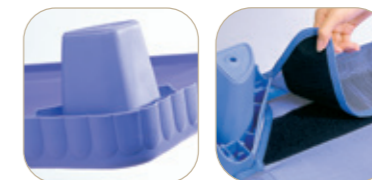

Easy to assemble with no tools required

Age: 0 y+

Dimensions: KE0014: 140 x 56 x 14 cm (L x W x H)

KE0015: 130 x 52.5 x 14 cm (L x W x H)

Maximum load: 50 kg

The extremely sturdy and stackable bed is lightweight and durable. The screwless, stable plastic corners and the breathable, washable and durable mat provide safety and comfort.



Stackable for easy storage  
Casters KE0018 are optional.



## KE0311-00K Modern Ball Chair (L)

Age: Adult

Components: Ball x 1 - Ø 48-52 cm

Chair x 1 - 50 x 60 x 77 cm (L x W x H)

Maximum load: 100 kg

Modern Ball Chair (L) is ideal for school, office and home use. The Ball Chair's flexibility and shape help to improve the user's balance and posture. The high chair back provides comfort and the tactile surface helps blood circulation.



KE0311-00K

KE0312

59 cm

42-44 cm

16.5 cm

3 y+

Phthalate-Free

Locking casters are included.



## KE0312 Modern Ball Chair (S)

Age: 3 y+

Components: Ball x 1 - Ø 35-39 cm

Chair x 1 - 50 x 47 x 59 cm (L x W x H)

Maximum load: 60 kg

Modern Ball Chair (S) is specially designed for children. Ball Chairs help to improve children's posture and sense of balance.



KE0312  
Modern Ball Chairs for  
Computer Classroom

### A Ball Chair with an Innovative Concept

Long-term desk working or incorrect posture will easily cause spinal disorders as your spine bears most of the body's weight when you sit on a chair.

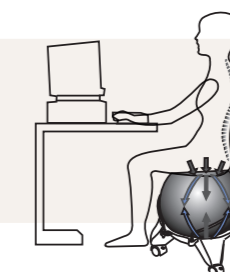

When users sit on a Modern Ball Chair, the spine only bears one third of the user's weight. The rest is absorbed by the gym ball. Hence, it helps to prevent back discomfort.

## KB1300 School Set

Phthalate  
-Free

- A KT3308 Massage Ball (Ø 7 cm x 5)
- B KT3307 Massage Ball (Ø 8 cm x 5)
- C KT3306 Massage Ball (Ø 9 cm x 5)
- D KB1303 Gym Ball (Ø 85 cm x 1)
- E KB1307 Gym Roll (Ø 40 x 80 cm x 1)
- F KB1302 Jumping Ball (Ø 40 cm x 2)
- G KB1301 Jumping Ball (Ø 55 cm x 2)
- H KB2301 To & Fro Ball x 4



Test of maximum loading



The School Set contains 25 balls in different shapes and sizes. The balls are suitable for improving children's reaction time, coordination and balance skills.

## KB3301 Baby and Toddler Set

Age: 0 y+

Components:

- A KT3308 Massage Ball (Ø 7 cm x 6)
- B KT3307 Massage Ball (Ø 8 cm x 6)
- C KT3306 Massage Ball (Ø 9 cm x 6)
- D KB0306 Massage Ball (Ø 75 cm x 1)
- E KB1309 Anti-Burst Ball (Ø 65 cm x 1)
- F KB0304 Half Massage UFO (Ø 40 cm x 1)
- G KB1307 Gym Roll (Ø 40 x 80 cm x 1)



Baby and Toddler Set includes 22 balls in 7 different sizes and shapes. They are perfect for various activities which help babies and toddlers to train their body strength, balance and coordination abilities.

## KB1303 Gym Ball

0 y+

Age: 0 y+

Dimension: Ø 85 cm  
Maximum load: 100 kg

Gym Ball is designed especially for children to learn how to sit and lie on the ball and strengthen their sense of balance.



## KB1302, KB1301 Jumping Ball

3 y+

Age: 3 y+

Dimensions: KB1302: Ø 40 cm  
KB1301: Ø 55 cm

Maximum load: 100 kg

The Jumping Ball is designed to promote hand-eye coordination, improving the control of body movement and strengthening leg muscles.



## KB1309 Anti-Burst Ball

0 y+

Age: 0 y+

Dimension: Ø 65 cm  
Maximum load: 100 kg

Anti-Burst Ball is designed to prevent any sudden burst when it is punctured by a sharp object.



## KB0306 Massage Ball

0 y+

Age: 0 y+

Dimension: Ø 75 cm  
Maximum load: 100 kg

The textured surface of the Massage Ball is suitable for rehabilitation, gymnastics and massages. It helps relax and stimulates muscles.



## KB0304 Half Massage UFO

0 y+

Age: 0 y+

Dimension: Ø 40 cm  
Maximum load: 100 kg

Half Massage UFO is great for tactile stimulation, balancing exercises and a lot of fun games. It also makes a great seat.



## KB2301 To & Fro Ball

3 y+

Age: 3 y+

Dimensions: Ø 20 cm, Rope 210 cm

To & Fro Ball is designed to promote hand-eye coordination. The rope is tied around the waist to save time on retrieving runaway balls. It also improves motor control and coordination of hands, eyes and feet.



## Massage System

Textured products provide sensory enhancement, relieve tension and increase emotional stability.

KT4301, KT4302, KT4303

### Air Cushion

Age: 0 y+  
Dimensions:  
KT4301: Ø 60 cm, KT4302: Ø 35 cm, KT4303: Ø 30 cm  
Maximum load: 100 kg

Air Cushion is an inflatable dynamic pad. It can be used on the floor to strengthen lower body muscles and to train for balance as well. One side of the cushion is bump-studded, while the other side is more gently textured to provide users with different sensations in order to enhance the sense of touch and coordination.



KT4301  
(Ø60 cm)



KT4301  
(Ø60 cm)



KT4302  
(Ø35 cm)

KT4302  
(Ø35 cm)

#### Different tactile surfaces:

▲ bump    △ light bump    □ smooth

	KT4303	KT4302	KT4301
Front	△	▲	▲
Back	□	△	□



KT4303  
(Ø30 cm)

KT4302  
(Ø35 cm)

KT4301 (Ø60 cm)

0 y+

Phthalate-Free

Phthalate-Free

## KT3310 (L), KT3311 (S) Olive Massage Ball

KT3310  
Age: 0 y+  
Dimensions: Ø 5 x 10.9 (L) cm

KT3311  
Age: 1 y 6 m+  
Dimensions: Ø 3.4 x 7.4 (L) cm

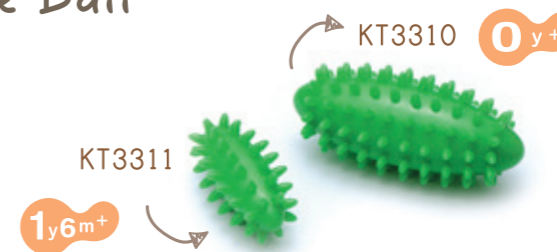

Moderate softness and suitable shape contribute to children's finger dexterity and stabilize their emotions.

Five-Finger Grip	Three-Finger Grip	Two-Finger Grip
Exercise grip strength	Train finger stability	Practice squeezing and releasing

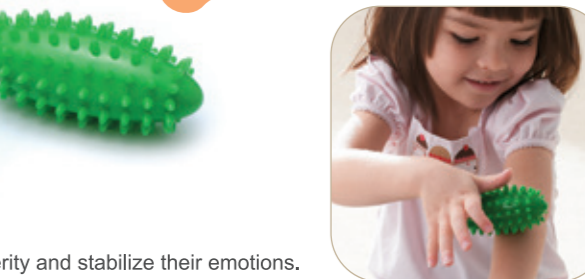

## KT3301 Massage Roll

Age: 0 y+  
Dimensions: Ø 5.8 x 15 (L) cm  
It is ideal for massage, reflexology, hand and relaxation therapy.

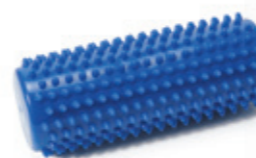

## KT3304 Massage Ball with Stick

Age: 10 m+  
Dimensions: Ball Ø 7 cm, Stick 32 cm (L)  
Massage Ball with Stick is good for blood circulation. The raised surface is perfect for tactile development. The stick handle is durable and flexible.

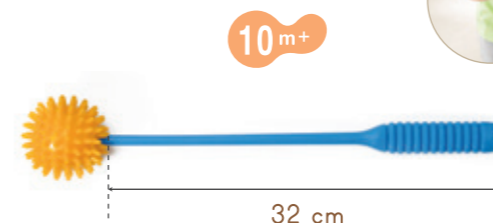
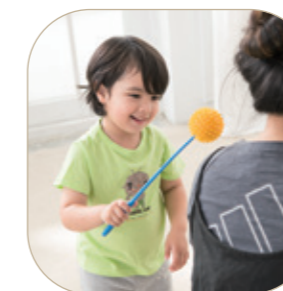

10 m+

32 cm

KT3308, KT3307, KT3306, KT3305

## Massage Ball

Age: 0 y+  
KT3308: Ø 7 cm  
KT3307: Ø 8 cm  
KT3306: Ø 9 cm  
KT3305: Ø 15 cm

Each Massage Ball is designed for offering sensory stimulation, relaxing muscles and soothing emotions. They are also ideal for sensory therapies.

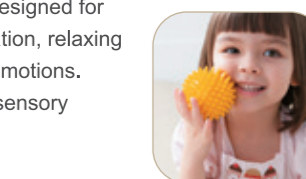

KT3306  
9 cm

KT3308  
7 cm

KT3307  
8 cm

KT3305  
15 cm

Building the learning foundation for children in each learning stage with the universal-designed products

# Instruction for Weplay Game-based Teaching Program

## Designed for Children's Development

The program is categorized into three age groups: 3-4 years old, 4-5 years old and 5-6 years old. Each fitness game and session is designed to enhance the physical development of a specific age group.

## Integrate the Learning Objectives through Systematic Sessions

1. There are 5 units for each age group. Each unit contains 8 sessions. Instructors may decide the frequency of sessions, such as once or twice a week.

3-4 years old	4-5 years old	5-6 years old
5 units, 40 sessions	5 units, 40 sessions	5 units, 40 sessions

2. The program is developed with the essence of the 'Five Areas of Holistic Development' and emphasizes children's holistic development. The first 6 sessions aim at 'basic movement practice', while the last 2 sessions are designed as 'integrated activities'.

<b>Session 1 to 6</b>	<b>Basic Movement Practice</b> These sessions are systematically designed and include gross motor skill movements, hand movements, cognitive games and group games.
<b>Integration 1 and 2</b>	<b>Integrated Activities</b> This part integrates the movements in the previous 6 sessions and allows instructors to observe children's learning progress.

## An Educational Equipment Mix for Instructors

In each unit, a specific educational equipment mix is used through the eight sessions and is shown with a table of contents on the first page of each unit. Four to five pieces of the equipment from the mix are used in a session. The mix saves instructors time in changing the equipment. This makes it easier for instructors to adjust and rearrange the activity setup. Instructors can increase or decrease the number of products or the length of an activity path according to the size of the venue and the number of participants. (The recommended number of participants for each session is 20 students.)



# Instruction of the Sessions

- It provides a clear image for instructors to understand the arrangement of the educational equipment.
- Instructors can adjust the resources. For example, the length or the number of activity paths can be adjusted according to the size of the venue and the number of participants.



### Objective

- ★ To enhance children's balance by letting them dodge and cross different obstacles.
- ★ To have children learn the difference of right and left by matching the Handprints and Footprints.

### Observation

- ★ Children are able to dodge and cross the obstacles and keep balance.
- ★ Children are able to complete Coral Adventure without stepping on the Columns.
- ★ Children are able to match the correct Handprints and the Footprints.

Age 5-6 Unit 2 Session 5

- **Objective:** The body movements and cognitive skills that children are able to experience and learn from the activity.
- **Observation:** The detailed description of what children are expected to achieve in each activity. Instructors can understand whether the skills or abilities are learned or practiced according to the description.

**The bottom text illustrates the specified age group, the number of units and the sessions.** Each book contains 5 units of sessions. There are 6 sessions and 2 integration sessions in each unit. For example, 'Age 5-6 Unit 2 Session 5' represents the 5th session in the 2nd unit for age 5-6; 'Age 5-6 Unit 3 Integration 2' represents the 2nd integration session in the 3rd unit for age 5-6.

- **Scenario:** The instruction provides an interesting background story for the activities. Instructors can guide children to create a new story with the products to enhance language skills, imagination and learning incentives.
- **Discussion:** This part acts as the bridge between the Scenarios and the Activity sections. A discussion helps instructors understand children's experiences on the activities. It also helps to discuss or brainstorm for the following activities.

### Storytelling and Discussion: 10 minutes

#### Activity

**Scenario**  
We are going to play Handprints Footprints matching game now, but my Footprints are missing! They are hiding deep in the forest. Be careful, there will be a lot of branches and holes on the ground. Please come back through the river once you find the Footprints! Please do not step on the fish in the river.

#### Discussion

1. Can you tell your right from left? (Display Handprints and Footprints, Ask children to match with their hands and feet.)
2. How can we bypass or dodge the branches and the holes?

### Activity One: 25 minutes

#### Warm Up

Guide children to warm up before the activities, for example, march on the spot, shake the arms for 30 seconds, do jumping jacks or stretch out the ankles.

#### Demonstration

1. Display one pair of Handprints and one pair of Footprints. Explain the concept of right and left.
2. Ask one child to demonstrate how to complete the path: Set off from Balance Beams and complete Honey Hills. Remember not to touch the obstacles on the way.
3. Pick one Footprint at the turn around point and walk on Coral Adventure. Remind children not to step on the Columns while walking.
4. Come back to the starting point and match with the correct Handprint. For example, match the left Handprint with the left Footprint.
5. Ask children to complete the task in turn until all the Handprints and Footprints are matched.

#### Loop Route

1. Set off from Balance Beams and complete Honey Hills.
2. Pick up one Footprint and complete Coral Adventure.
3. Complete the Handprints Footprints matching activity.

### Activity Two: 15 minutes

#### Rearrangement

1. Mix the Handprints and Footprints together. Place half of them at the starting point and another half at the turn around point.
2. Place some Hoops on the Poles as the new obstacles.

#### Demonstration

1. Remind children not to touch the new obstacles on the way.
2. Same as Activity One, Pick up one Handprint or Footprint at the turn around point and match with correct Footprint or Handprint at the starting point.
3. Ask children to complete the task in turn until all the Handprints and Footprints are matched.

**Loop Route** Same as Activity One, Dodge the new obstacles and finish the matching activity.

Age 5-6 Unit 2 Session 5

### Each session consists of 2 activities:

1. Activity One: It focuses on basic movements and rules of the activity.
2. Activity Two: It is proceeded with the route or activity with a higher level of challenge.



# KIDDIE'S PARADISE INC.

9FL., NO. 70, SEC.5 NANKING EAST RD., TAIPEI 105, TAIWAN

TEL: 886 2 27568001

FAX: 886 2 27616457

e-mail: kp@weplay.com.tw

www.e-weplay.com



Weplay cares about KIDS!  
[www.e-weplay.com](http://www.e-weplay.com)

